

ADAPTER, CONNECTING

Useful for simple distillation with take-off tube positioned at a 75 degree angle. All three joints are the same size on each adapter.

CATALOG #	JOINT SIZE		
00500	19/22	35-D	

**ADAPTER, CONNECTING, CLAISEN**

Ground joints, sidearm parallels main arm and extends upward. Upper ends have outer joints and bottom end has inner joint.

CATALOG #	JOINT SIZE		
00529	19/22	35-D	

ADAPTER, ENLARGING AND REDUCING

With Standard Taper inner joint at bottom and outer joint at top.

CATALOG #	TOP (INNER)	BOTTOM (OUTER)	
00509	24/40	14/20	34-D
00514	24/40	19/22	35-B





ADAPTER, INLET

For use with gas inlet tubes or plain stem thermometers,
Supplied with one holed rubber adapter. 19/22 male joint.

CATALOG #	00012	35-B
------------------	-------	------



ADAPTER, UNIVERSAL, GLASS, INLET OR THERMOMETER

Glass Joint with a compression cap and Viton o-ring to form a vacuum tight seal. To use it as a syringe port, simply replace the o-ring with Teflon lined septum. Cap accommodates 5.0-7.5mm O.D. thermometer. Supplied with one Nylon cap and one o-ring.

CATALOG #	JOINT SIZE	
00519	19/20	35-A
00520	24/40	36-E

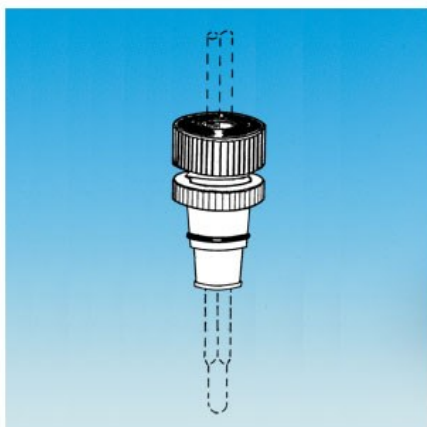

ADAPTER, UNIVERSAL, TEFLON, INLET OR THERMOMETER

PTFE adapter with FETFE O-Ring for use with plain stem thermometers, gas inlet tubes, etc. O-Ring compression seal allows adjustable depth positioning. 10/18 size will accommodate tubes up to 6.5mm, all other sizes up to 7mm. All sizes have one internal O-ring size -108. Except for 10/18 size, all sizes have one external O-ring seal.

CATALOG #	JOINT SIZE	
01210	14/20	34-D

TUBE, VACUUM, CONNECTING

With outer Standard Taper joint at the top and inner-sealed through drip-tip inner standard taper joint of the same size at the bottom. Bent at 105° angle. The serrated sidearm is 10mm O.D.

CATALOG #	JOINT SIZE	
00523	19/22	35-A

**ADAPTER, VACUUM, INNER JOINT**

Allows for flexible tubing to be connected to apparatus for introduction of vacuum or pressure. Hose connection has an O.D. of 10mm at the largest serration.

CATALOG #	JOINT SIZE	
00015	24/40	36-E

**ADAPTER, VACUUM, FILTER FLASK**

Tapered, collar-type holders. They support funnels, crucibles, and other equipment in vacuum-type filtration assemblies. These holders can be used alone or with adjacent sizes. Made of neoprene rubber. Autoclavable.



CATALOG #	O.D. TOP X BOTTOM (MM)	I.D. TOP X BOTTOM (MM)	HEIGHT (MM)	WALL THICKNESS (MM)	
00530	28 X 16	23 X 11	20	2.5	3-P
00531	37 X 22	31 X 16	25	3	3-P
00532	46 X 28	40 X 22	30	3	3-P

AIR DUSTER

Air dusters blast clean, filtered, moisture-free, high-pressure gas to remove dust, dirt, lint, hair, sand, sawdust, moisture, and microscopic debris from hard-to-reach areas or delicate surfaces such as keyboards, printers, computers, cameras, lenses, audio gear, sensitive instruments, and other office equipment or electronics. Duster will not harm glass, optics, metals, plastics, rubber, or hardware. A unique variable pressure trigger allows for control of dusting pressure. Duster gas is 100% pure, non-flammable, non-ozone depleting, and filtered to 0.2 microns.

10 oz.

CATALOG # 00010 4-A



APPLICATOR, WOODEN, COTTON-TIPPED

These swabs are ideal for use in bacteriology labs for inoculating broth and plated media, and obtaining culture specimens. They are also useful for cleaning delicate laboratory instruments.

Swabs do not contain adhesive. Swabs are autoclavable.

Sold in packs of 100 applicators.

CATALOG # 00417 83-B





ASPIRATOR, FILTER PUMP, METAL

Humboldt Aspirator Filter Pumps offer excellent performance for vacuum filtrations under both high and low water pressure conditions. The pumps feature a ball-type, positive-action valve in the suction tube which prevents water backflow if the pressure is reduced.

CATALOG # 00162 3-G



ASPIRATOR, FILTER PUMP, NALGENE

Maximum free air pumping capacity of 11.5L per minute at a water flow rate of 6.5L per minute. Provides vacuum to 723.9mm Hg (28.5in. Hg). Operates efficiently at water pressures as low as 7.5psig. Safe with corrosive materials. (NNI 6140-0010)

CATALOG # 00369 78-C

ASPIRATOR, SPLASHGON

Eliminates splashing. A rubberized cylinder with neck that fits outlet of 00162 aspirator. Maximum diameter, 1 1/4" (3.2 cm). Brass device inside cylinder eliminates restrained air, spreads water stream, decreases water speed to 1/14 of original speed.

CATALOG # 00164 78-C



BAGS, ZIPLOCK, WHITE BLOCK

Label your bags the easy way with white block bags. These polyethylene bags open and close with zipper and provide a highly visible block for writing part numbers and content information.

Comes in packs of 100, but bags are sold individually.



BAGS, ZIPLOCK, ANTI-STATIC

These 4 mil polyethylene bags meet electrostatic requirements of MIL-B-81705 Type II. Dissipates an induced charge up to 5000 volts within two seconds. Keeps electronic parts clean and dust-free. Zip-lock feature repeatedly seals bags.



TYPE	CATALOG #	SIZE	
White Block	01200	2" x 3"	74-A
White Block	01201	3" x 5"	74-A
White Block	01202	4" x 6"	74-A
White Block	01203	5" x 8"	74-A
Anti-Static	01204	2" x 3"	74-B
Anti-Static	01205	3" x 5"	74-B
Anti-Static	01206	4" x 6"	74-B
Anti-Static	01207	6" x 8"	74-B

BEAKER, PYREX, GRIFFIN

Beakers are of the low, wide form most commonly used for general laboratory procedures. Beakers have approximate graduations on one side.



CATALOG #	CAPACITY (ML)	
00535	10	27-TOP
00536	30	27-TOP
00537	50	28-TOP
00538	100	28-TOP
00539	150	28-TOP
00540	250	28-A
00541	400	28-A
00542	600	28-B
00543	800	28-B
00544	1000	28-C
00545	2000	28-C

BEAKER, POLYPROPYLENE, NALGENE

Heavy duty polypropylene. Easy-pour spouts, tapered sides for easy handling and stacking. Approximate volume scales located near spout.

CATALOG #	CAPACITY (ML)	
00422	100	77-C
00548	250	77-C
01130	400	77-C
00423	600	77-C
00549	1000	77-C



BEAKER, POLYPROPYLENE, TRI-CORNER

Chemically resistant. Triangular flange forms rim into three shallow pouring spouts; can also serve to support beakers in openings of water bath. Volume of contents can be easily read in normal light.

CATALOG #	CAPACITY (ML)	
00019	50	32-B
00020	100	32-B
00550	250	32-B
00551	800	32-C
01133	1000	32-C



BENCH PROTECTION, LABMAT

Disposable bench and drawer liner simplifies clean up and safeguards work surfaces from stains, spills, and wear. Flexible plastic film backing is non-skid and prevents soak-through of most solutions. Absorbent upper surface traps water, dyes, corrosive chemicals and radioactive solutions. 20" x 50' roll.

CATALOG # 00048 33-TOP



BOTTLE, MEDIA, WITH CAP

Reusable borosilicate glass media bottle with screw on polypropylene cap. With permanent white enamel marking spot and enhanced graduations. GL 45 screw thread. Clear (natural), drip-free, replaceable polypropylene pour ring . Autoclavable (to 140°C).



CATALOG #	CAPACITY (ML)	
01310	100	26-Top
01311	250	26-Top
01312	500	26-A
01313	1000	26-B

BOTTLE, BARNES DROPPING

Flint glass, complete with rubber stopper and nipple.
Capacity 30 mL. Base dimensions 43 mm sq. x 100 mm high.

CATALOG # 00035 91-C



BOTTLES, BOSTON ROUND, CLEAR and AMBER, NARROW MOUTH

Clear flint glass for maximum content visibility. Amber glass to protect light sensitive contents. Supplied with Poly-Seal lined closures that form an exceptional seal. Narrow mouth design. Perfect for general lab use. Ideal for solvent and sample storage.

CATALOG #	CAPACITY (OZ)	GLASS	
00552	1	CLEAR	25-A
00553	2	CLEAR	25-A
00554	2	AMBER	25-A
00555	4	CLEAR	25-A
00556	4	AMBER	25-B
00557	8	CLEAR	25-B
00558	8	AMBER	25-B
00559	16	CLEAR	69-TOP, A
00560	16	AMBER	70-TOP
01142	32	AMBER	24-C



BOTTLES, CAPS, REPLACEMENTS FOR 00552—01142 ABOVE

Black phenolic caps with Poly-Seal liners. Conical-shaped polyethylene liner forms an especially tight seal with the inside and top of the bottle neck. The depth of the closure skirt provides additional thread engagement to resist “backoff”. For use with bottles 00552 thru 01142 above.

CATALOG #	SIZE (MM)	FOR BOTTLE SIZE	
01143	20	2 OZ	69-D
01144	22	4 OZ	69-D
01145	24	8 OZ	69-D
01146	28	16 OZ	69-D





BOTTLE, GLASS, STOPPERED

Hollow Standard Taper stoppers. Plain narrow-mouth bottles with ground necks. Well suited for storing reagents, sera, vaccines, colloidal solutions, and similar liquids

CATALOG #	CAPACITY (ML)	
00575	125	70-D
00577	500	70-D
00578	1000	70-D



BOTTLE, HIGH FORM, WIDE MOUTH

Of clear glass, or amber glass for light sensitive materials. Excellent for mixing and storing solutions and chemicals in the laboratory, for quality control and field samples. Supplied with pulp/vinyl-lined black phenolic caps attached.

CATALOG #	CAPACITY (OZ)	GLASS	
00561	1	AMBER	24-TOP
00563	4	CLEAR	24-TOP
00565	8	CLEAR	24-TOP
00566	8	AMBER	24-A
00568	16	AMBER	24-B
00569	32	CLEAR	24-B



BOTTLE, LOW FORM, WIDE MOUTH

Clear glass for maximum content visibility. Bottles supplied with black phenolic caps with flat, disc-type polyvinyl liners. Caps are not autoclavable.

CATALOG #	CAPACITY (OZ)	
01262	1	25-C
00571	2	25-C
00572	4	26-C
00573	8	26-C
00574	16	26-C

BOTTLE, POLYETHYLENE, BOSTON ROUND

High density polyethylene bottles with polypropylene caps. Ideal for storing, shipping, and packaging liquids for long periods. Rigid and translucent, with excellent chemical resistance. Leakproof. Can be used with most corrosives

CATALOG #	CAPACITY (ML)	
00579	125	33-C
00582	250	33-C
00580	500	33-E
00581	1000	33-D
00589	500 (wide mouth)	33-A
00590	1000 (wide mouth)	33-C

**SPRAY BOTTLE, PRE-LABELED**

These empty spray bottles come with pre-affixed GHS labels for a 70% ethanol solution, including pictograms and signal words. Each bottle holds 16 oz.

CATALOG #		
01412		9-A

**BOTTLE, WASHING, POLYETHYLENE**

Translucent white, low density polyethylene (LDPE). With one-piece polypropylene screw cap and nozzle. Deliver single drop or fine stream. Tip may be cut back to increase flow. Labeled right-to-know bottles have built in vent to prevent vapor pressure and dripping.



Regular			Right to Know Hazard Labeled		
CATALOG #	CAPACITY (ML)		CATALOG #	CAPACITY (ML)	
00583	125	33-B	01280	Acetone 500 mL	9-A
00584	250	33-B	01279	Isopropanol 500 mL	9-A
00585	500	33-C			

BOTTLE, WEIGHING

Of Kimax glass. Plug-style stopper fits into internally ground body. Stopper has closed bottom.

CATALOG #	I.D. x HEIGHT (mm)	
00586	25 x 50	77-D



BRUSHES, VARIOUS

00591 –BURET 91-B

Tapered bristle section, 7/8" diameter x 5.25" long. Wire handle. Total length is 36".

**00593—BEAKER 21-B**

Excellent for cleaning large beakers. Sturdy black bristles twisted into galvanized wire; mounted on hard wood handle 5/8" diameter. Brush area is 5" long and tapered from 2.5" at top to 2" at bottom.

**00595—FUNNEL 21-B**

Useful for cleaning funnels and a variety of glassware. Twisted wire holds the tapered bristles. Overall length is 13", while the brush head is 6".

**00594—FLASK 21-A**

White bristle brush, 1.25" diameter with flexible backing. Total length, including plastic handle, is approximately 12".

**00596—PIPET 21-A**

For cleaning barrel chamber and tip in one operation. Brush part is 7.5" long. Large part 3/4" diameter by 2.5" long. Small part 1/4" diameter by 5" long. Total length is 17".

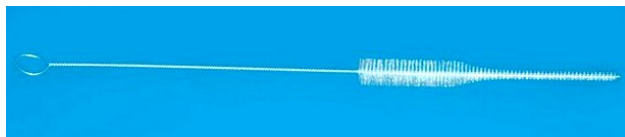
**01120—TEST TUBE 3-R**

Bristle size: 1/2" wide by 3" long. For cleaning test tubes, small bottles, and centrifuge tubes. Tufted end for getting into corners.

**01121—TEST TUBE 3-R**

Bristle size: 3/4" wide by 4" long

**01122—TEST TUBE 3-R**

Bristle size: 1.5" wide by 5" long

**00898—PIPE CLEANER, 3MM O.D. 91-B**

For cleaning tubes, pipets, stopcock bores, etc. Made of white yarn bound in twisted wire, flexible to permit shaping to various applications.

**01119—Nessler Tube, Wire Handle 21-A**

Total length is 11". Bristle size: 1.57" wide by 4" long. Bristles made of natural material.



BULB, PIPET, DISPOSABLE

Small-volume, natural rubber latex bulbs are designed for use with Pasteur pipets, small pipets, and medicine droppers.



CATALOG #	CAPACITY	
00598	1 mL	20-Top
00599	2 mL	20-Top



BULB, PIPET-AID

This useful item aids in pipetting reagents safely. Consists of an 85 mL vinyl suction bulb and special polyethylene fitting. In use, the top of a pipet is inserted in the conical opening of the fitting and suction is applied by squeezing the bulb. The pipet is then quickly removed from the fitting and the top covered with a finger. The conical shape of the fitting allows for quick removal of the pipet after filling.

CATALOG #	00043	20-Top
-----------	-------	--------

BULB, SAFETY PIPET FILLER

Tough 100% natural rubber patented pipet fillers improve worker safety by eliminating mouth pipetting and handling of hazardous materials. Two stainless-steel ball valves control vacuum for precise filling and delivery of pipets with one hand. Measurements to 1/100 mL are easily made and reproduced with this bulb. Long-throat design accommodates ultra-micro, volumetric and serological pipets. Ball valves act independently and can easily be manipulated with one hand to create a vacuum, draw up solution and deliver to the precise meniscus.



CATALOG #	00045	92-C
-----------	-------	------



BURET, STRAIGHT BORE PTFE STOPCOCK

Economical, versatile buret composed of four replaceable components. The graduated barrel has a reinforced top and a lower end ruggedly constructed and accurately tooled to provide precise fit with a PTFE stopcock assembly. A ground top fits into lower end of stopcock.

CATALOG #	ITEM	
00600	50 mL Complete	93-B
00601	25 mL Body Only	93-C
00602	50 mL Body Only	93-D
00603	25 + 50 mL Tip Only	93-C
00936	25 + 50 mL Stopcock	93-C

CARBOY, WASTE, HDPE

Large mouth container. Handy carrying handle. Constructed of high-density polyethylene. Lightweight. Suited for use with food, chemicals, and more. Meets U.N. regulations for transport of many hazardous materials, and resin meets FDA standards. Designed for efficient palletization. Reusable, reconditionable, and recyclable. Lids are HDPE with gasket. Not suitable for use with fuels or oils.



CATALOG #	CAPACITY	
00466	2.5 gallon	15-TOP
00468	5 gallon	4-15-TOP



CARBOY, HDPE, WITH SPIGOT

This sturdy UN and FDA approved container is ideal for shipping, liquid storage, and shelf dispensing. It has an 18mm, molded-in vent cap and a 70mm linear LDPE screw cap with 3/4" NPT(F) thread that accommodates a 3/4" NPT(M) LDPE drum faucet. Not suitable for hazardous materials. Capacity is 5 gallons.

CATALOG #	00462	36-TOP
-----------	-------	--------

CHROMATOGRAPHY PLATES, EASTMAN

Highly uniform, prepared plates of silica gel sorbent for thin layer chromatography. The plates are thin, flexible, easy to handle and cut to size, and are adaptable to paper thin layer techniques. The plates comprise a semi-transparent flexible backing of polyethylene upon which is laid a coating of aluminum oxide of carefully controlled thickness. Slightly alkaline, thus suited for separations of relatively nonpolar basic organic compounds (chlorinated pesticides, fat-soluble vitamins, DNPH derivatives of some carbonyl compounds). Sorbent thickness is 100uM, sheets are 20cm x 20cm.

CATALOG # 00092 94-A



CLAMP HOLDER

Holds two rods at a 90 degree angle. Accepts rods up to 20 mm in diameter.

CATALOG # 00097 78-A

CLAMP, EXTENSION, 2-PRONG

Securely holds laboratory glassware and apparatus. Extension arm attaches to clamp head and offers easy positioning. Clamps are constructed with round extension arms that allow the clamps to be rotated 360°. Opening is gradual to maximum angle, without binding. Comes with both non-slip vinyl sleeves.



CATALOG #	MAX GRIP SIZE	OVERALL LENGTH	
00606	1.5"	8"	22-B
00607	2.5"	9"	22-B

CLAMP, EXTENSION, 3-PRONG

Same as 2-prong clamps above, but has 3 prongs for a more secure hold.



CATALOG #	MAX GRIP SIZE	OVERALL LENGTH	
00608	1"	6 1/2"	22-B
00609	2 1/4"	8 3/4"	22-C
00610	3 1/2"	10 1/2"	22-C

CLAMP, TEST TUBE

Excellent for holding or carrying 1/4" diameter to 1" diameter (6 to 25mm) tubes. Nickel plated brass won't rust or corrode. Self closing jaws.



CATALOG #	00106	87-A
-----------	-------	------



CLAMP, TUBING, ACETAL

Tube clamp is molded of strong, durable plastic with serrated jaws 2.7cm (1 1/16") long. Attach at any point on tubing without disconnecting tubing. Designed to be operated with one hand, the clamp locks closed and opens when the locking tab is released. For use on tubing up to 1.3cm (1/2") O.D. and wall thickness of 0.82mm (1/32") or thinner.

When not in use, the circular opening (approximately 0.6cm (1/4") diameter) at hinge end allows clamp to remain attached to tubing having 0.6 - 1.0cm (1/4 - 3/8") OD with little to no restriction in flow. Overall length is 5.9cm (2 5/16"). Autoclavable.

CATALOG #	00028	R-2
-----------	-------	-----



CLAMP, TUBING

For use with thin wall tubing from 1 1/8" to 1/2" O.D. Fifteen position ratchet makes it possible to control flow down to shutoff. Made of one-piece, molded plastic.

CATALOG # 00419 R-2

CLAMP, TUBING, WIRE

Eliminates older method of wiring rubber tubing to glass. Simple in design, low in cost and easy to use. Requires only one hand to apply; can be instantly applied or removed. Fits standard 10-12mm fittings.

CATALOG # 00033 R-2



CLAMP, TUBING, PINCHCOCK, MOHR

For use with rubber tubing. Heavy, strong, self-closing, quick acting. Spring bronze, nickel plated. Round edges prevent cutting of tubing. For tubing up to 1/2".

CATALOG # 00612 R-1

CLAMP, TUBING, WORM DRIVE

Stainless steel clamps join flexible tubing with serrated pipe or hosecocks. Easily adjustable by rotating screw. Has positive 360 degree sealing. Band disengages for application without disconnection assembly.



CATALOG #	SIZE	
00410	5/16" to 5/8" 7.9 to 15.9 mm	R-1
00615	7/16" to 11/16" 11.1 to 17.5 mm	R-1
00616	1/2" to 1-1/16" 12.7 to 27.3 mm	R-1
00617	3/4" to 1-3/4" 19.1 to 44.4 mm	R-1

CLAMP, SNAP GRIP

Secures tubing and hose in seconds, just snap shut with pliers. Safe and economical. Twist action with pliers removes clamp. Made of acetal. Max temp 200°F.

Catalog #	Dimensions	
30389	0.228" x 0.256"	R-2
30390	0.351" x 0.394"	R-2
30391	0.499" x 0.511"	R-2



CLAMPS, KECK, STANDARD TAPER JOINTS

Made of Delrin®, the clamp is non-corrosive and will not scratch glass. Can be used to 140° C. Color coded for easy identification.

Catalog #	Item Description	
00114	Yellow, Fits Joint Sizes 14/20 & 14/35	36-E
00115	Blue, Fits Joint Sizes 19/22 & 19/38	34-B
00113	Green, Fits Joint Sizes 24/40 & 24/25	35-F



CHROMATOGRAPHY COLUMN

General purpose column has a Teflon stopcock and top outer joint. Used for flash chromatography, with a heavy wall to increase safety. When using positive air pressure, it's highly recommended that operator uses column behind a safety shield. Has a 46 mm column O.D., 40 mm column I.D., and a 24/40 Joint. Effective length of 18", and stopcock bore of 2 mm.

CATALOG # 00146 34-E



DISTILLING COLUMN

Jacketed distilling column has indentations on the inner tube to support packing material. Outer 19/22 ground joint on top; Inner 19/22 ground joint with drip tip at bottom. Two 10mm hose connections for flexible tubing. Jacket permits column to be used as a condenser. 200 mm jacket height.



CATALOG # 00144 35-A

CONDENSER, WEST, LIEBIG

Narrow annular space between jacket and inner tube of the West condenser provides for excellent cooling efficiency due to the increased flow rate of water. Condenser has a top standard taper outer joint and a lower inner drip tip joint. Hose connections have an O.D. of 10mm at the middle serration.



CATALOG #	JOINT SIZE	JACKET LENGTH	
00620	14/20	110 mm	34-D
00621	19/22	200 mm	35-A

CONDENSER, LIEBIG

Condenser has a standard taper outer joint at the top and a lower inner drip tip joint. Hose connections have an O.D. of 10mm at the middle serration. 24/40 joints and 300mm jacket length.



CATALOG #	00110	36-F
-----------	-------	------

CONDENSER, ALIHN

Allihn style reflux condenser with a standard taper outer joint at the top and a lower inner drip tip joint. Hose connections have an O.D. of 10mm at the middle serration.

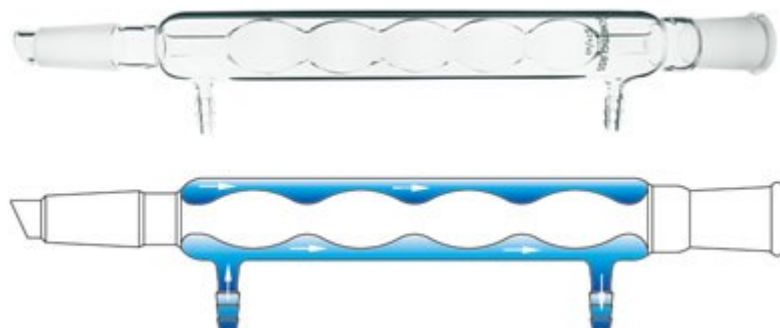

CATALOG #	00111	36-F
-----------	-------	------

CONNECTORS, QUICK DISCONNECT COUPLINGS

Chemical Resistance - Can be used where brass is not desirable

Cost Saving - Chemical resistance without the high cost of stainless steel

Lightweight - Applicable where small tubing and light materials are a must

Materials - Bodies and valves; acetal plastic

Springs and latch; stainless steel

Seals; Buna—N

Maximum operating temperature - 180 degrees F

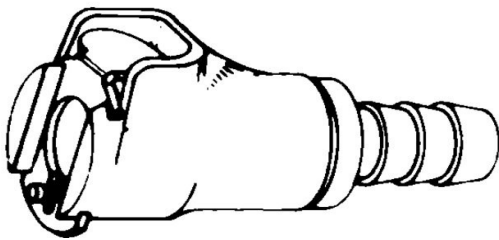

IN LINE COUPLING BODY W/ SHUTOFF

CATALOG #	SIZE
00371	1/4" FLOW 1/4" TUBING R-9



STRAIGHT THRU - COUPLING, INSERT - HOSE BARB

CATALOG #	SIZE
00391	1/4" FLOW 1/4" TUBING R-9

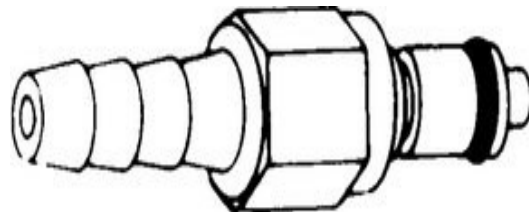

W/ SHUT-OFF COUPLING, INSERT HOSE BARB

CATALOG #	SIZE
00390	1/4" FLOW 3/8" TUBING R-9

CONNECTOR, T, GLASS

Pyrex brand glass with ends fire polished and constricted to same size to hold rubber tubing firmly.



CATALOG #	SIZE	
00622	3/16"	R-3
00624	5/16"	R-3



CONNECTOR, T, POLYPROPYLENE

For connecting rubber or plastic tubing. T shape, with serrated hose connections.

CATALOG #	SIZE	
00629	3/16"	R-3
00630	3/8"	R-3



CONNECTOR, Y, POLYPROPYLENE

Similar to 00629 and 00630, but of Y shape.

CATALOG #	SIZE	
00631	3/16"	R-3
00632	1/4"	R-3
00633	3/8"	R-4
00365	1/8"	R-3
00366	1/2"	R-4



CONNECTOR, UNIVERSAL, STOPCOCK

For on/off, restricted flow or sampling applications, the Hayward StopCock is easily adaptable to any piping connection. Furnished with the valve is a 1/4" NPT female pipe thread, 1/4" NPT male pipe thread and hose barb end connectors for 1/4" through 7/16" I.D. tubing. These allow the valve to be fitted with up to six different end connection combinations. Simply attach the end connections you need – they are all supplied with

CATALOG # 01231 R-1



Connector, Quick Disconnect

All sizes are interchangeable with others to make reducing combinations. For use in connecting and disconnecting vacuum lines and other tubing assemblies. Operate at temperatures up to 80C (176F)

CATALOG #	Tubing I.D.	
00433	3 TO 6MM (1/8 TO 1/4")	R-4
00434	6 TO 9MM (1/4 TO 3/8")	R-4
00634	9 TO 12MM (3/8 TO 1/2")	R-4



Connector, Check Valve

For use in vacuum lines and to prevent back pressure in filter flasks. Not for use with liquids. Tubing connections are 3/4" long and fit 1/4-5/16" I.D. tubing. Withstands temperatures up to 82.2°C (180°F). Works best between 254–508mm Hg (10–20in. Hg).

CATALOG # 00117 R-4

CONTAINER, HDPE, FOR GLASS DISPOSAL

HDPE bucket intended for disposal of broken glass wear or similar material wastes. Bottom won't be cut or become soggy like cardboard glass containers. white in color. Size is 5 US gallons. Typical metal handle with rolling plastic grip piece. Includes white plastic Snap-on lid.



CATALOG # 00151 16-Top



CONTAINER, CARDBOARD, FOR BROKEN GLASS

This floor-model box comes with a 2 mm thick polyethelene liner and lid. Used to store broken glass in a safe manner. Designed to be sealed and thrown away whole when full. Some assembly required.

Dimensions are 12 x 12 x 27 inches (30 x 30 x 69 cm).

CATALOG # 00142 37-Side

CONTAINER, SHARPSAFETY, SHARPS CONTAINER

Polypropylene container for disposal of waste materials. Multi-purpose container with plastic lid. Lid has a circular rotor opening to quickly open and close. Can be used for biohazard/regulated medical waste, n.o.s. under UN 3291.



CATALOG #	Size
00255	~2 L 18-TOP
00262	~7.6 L 18-TOP

CORK RINGS, FLASK SUPPORTS

Durable, compressed first quality cork lab rings with concave recesses to support dishes and round-bottom flasks.



CATALOG #	I.D. x O.D. (MM)	FOR FLASK SIZE
00662	30 x 80	10 to 100 mL 32-D
00660	60 x 110	200 to 500 mL 32-D
00661	90 x 140	1000 to 3000 mL 32-D



CATALOG # 00125 87-A

CRUCIBLE HOLDER

Rubber with removable glass stem ground at 45 degree angle. Fits neck of filter flasks that take rubber stopper sizes 6, 7, or 8. Tapered rubber portion of holder is 1 1/2" (38mm) at top and 7/8" (22mm) at bottom. Top of glass stem, inside the holder, is flared to collect filtrate.

CRUCIBLE, PORCELAIN

Coors. Glazed inside and out except for outside bottom surface and rim.

CATALOG #	CAPACITY	DIAMETER X HEIGHT	
00664	5 mL	15/16 x 25/32"	(24 x 20 MM) 88-A
00665	10 mL	1 3/16 x 1"	(31 x 26 MM) 88-A
00666	15 mL	1 3/8 x 1 1/8"	(35 x 29 MM) 88-A
00667	17 mL	1 5/8 x 1"	(41 x 26 MM) 88-A
00668	30 mL	1 11/16 x 1 7/16"	(43 x 37 MM) 88-A
00669	40 mL	2 x 1 5/8"	(50 x 40 MM) 88-B
00670	50 mL	2 1/16 x 1 11/16"	(53 x 43 MM) 88-B
00671	100 mL	2 7/16 x 2 1/8"	(65 x 54 MM) 88-B



CRUCIBLE COVER, PORCELAIN

Coors. Glazed everywhere except on rim.



CATALOG #	I.D.
00672	1" (26 MM) 88-C
00673	1 5/16" (34 MM) 88-C
00674	1 1/2" (38 MM) 88-C
00675	1 11/16" (43 MM) 88-C
00676	1 3/4" (45 MM) 88-C
00677	2 1/8" (54 MM) 88-C
00678	2 3/4" (66 MM) 88-C
00679	3 1/2" (90 MM) 88-C

CYLINDER, GRADUATED, GLASS

Sizes 10 thru 100 mL are made of borosilicate glass. Come complete with plastic base and bumpers to protect against breakage. Calibrated "To Deliver". 10 mL size has funnel-shaped top.

Sizes 250 to 1000 mL are made of borosilicate glass and come with plastic bumper. These cylinders are calibrated "To Contain".



CATALOG #	CAPACITY (ML)	CALIBRATED TO	
00685	10	DELIVER	27-TOP
00686	25	DELIVER	27-TOP
00687	50	DELIVER	27-TOP
00688	100	DELIVER	27-A
00689	250	CONTAIN	27-A
00690	500	CONTAIN	27-A
00691	1000	CONTAIN	27-A

CYLINDER, POLYPROYLENE

One-piece molded construction with permanently molded-on graduations and octagonal base. One-piece polypropylene construction prevents possibility of leakage or contamination. Repeated autoclaving may alter accuracy. Calibrated "To Contain".

CATALOG #	CAPACITY (ML)	
01140	100	32-D
00694	250	32-E
00695	500	32-E
00696	1000	32-E



DESICCATOR COVER

Replacement covers for use with desiccators.

CATALOG #	I.D. MM (INCHES)	
00702	150 (6)	94-C
00703	200 (8)	94-C

**DESICCATOR PLATE, PORCELAIN**

Has 30mm diameter holes for supporting crucibles. Made of porcelain, glazed on top and supported by three 16mm feet.

CATALOG #	DIAMETER (MM)	# OF HOLES	
00704	95	3	94-C
00705	115	4	94-C
00708	230	8	94-C



DETERGENT, ALCONOX POWDER

Concentrated detergent is ideal for removing soil, grit, buffing compounds, and other organic contaminants from glass, metal, stainless steel, porcelain, ceramic, plastic, rubber, and fiberglass. Leaves no interfering residue. Noncorrosive, high-foaming formula can be used on soft metals. Consists of homogeneous blend of sodium linear alkylaryl sulfonate, alcohol sulfate, phosphates, and carbonates. Free-rinsing, odorless, anionic, and mild (pH 9.5). Biodegradable. Dilute 1:100. Comes in 4lb containers capable of making up to 52 gallons of solution.

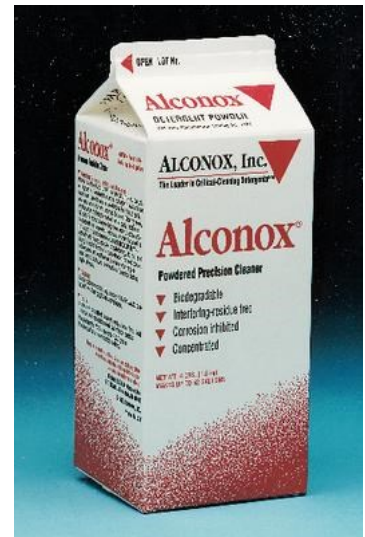

CATALOG # 00001 6-A

DETERGENT, CONTRAD 70

Contrad 70 liquid detergent concentrate is non-toxic, phosphate-free, chlorine-free, and biodegradable. Cleans glass, plastic, ceramic, and ferrous metals by soaking, manual scrubbing, or ultrasonic cleaning. Easily removes proteins, grease, oil, and baked-on contaminants. Can safely replace acid washes and caustic baths. Excellent substitute for chromic acid. Contrad 70 is free-rinsing and disposable straight to the drain. Made with recycled packaging. Comes in 1L bottles.



CATALOG # 00718 6-A

DETERGENT, MICRO-90

A powerful, multi-purpose liquid for precision cleaning of glassware, filter membranes, laboratory equipment, electronics, metal parts, plastics, and other surfaces. Best used in manual, immersion, and low-pressure or low-agitation systems. Ideal for use in ultrasonic cleaners. This mildly alkaline, aqueous cleaner lifts, disperses, emulsifies, sequesters, dissolves, suspends, and decomposes soils. Mixes instantly with water. Highly-concentrated — a one liter container of cleaner makes over 12 gallons at 2% solution. Safe-to-use. Cleaner is environmentally friendly, with no CFCs, ODCs, phosphates, or phenols.



CATALOG # 00709 6-A

DISH, CRYSTALLIZING

The rims on these dishes are reinforced and fire polished to reduce chipping. Can withstand repeated sterilization (wet or dry). Ideal for storage and crystallization. Flat bottom and straight sides.

CATALOG #	DIA. X HEIGHT (MM)	CAPACITY (ML)	
00710	70 X 50	180	19-C
00711	100 X 50	325	19-C
00712	150 X 75	890	19-C
00713	190 X 100	2500	19-C

**DISH, EVAPORATING, DEEP FORM**

Chemical-porcelain deep-form dishes feature a lip, round bottom, and glazing inside and out, except for rim and part of outside surface. Highly resistant to chemicals. For use in temperatures up to 1150°C (2102°F).



CATALOG #	DIAMETER (MM)	CAPACITY (ML)	
00714	60	35	88-D
00715	75	70	88-D
00716	90	120	88-D

DISH, EVAPORATING, SHALLOW FORM

Shallow-form dishes feature a lip, flat bottom, and glazing, except for rim and part of outside surface. Highly resistant to chemicals. For use in temperatures up to 1150°C (2102°F).

CATALOG #	DIAMETER (MM)	CAPACITY (ML)	
00720	70	30	88-D
00721	90	75	88-D





DISH, PETRI, CULTURE, GLASS

These flat, clear dishes will withstand repeated sterilization (wet or dry). The edges are beaded to provide greater mechanical strength. The bead also provides a means to equally space the side walls of the bottom and cover, thereby reducing the capillary action of condensed moisture on the sides. They are not affected chemically or thermally by any of the methods commonly employed in laboratories where sterilization is a major factor in routine or in specialized work. The covered dish is not airtight.

CATALOG #	DIAMETER X HEIGHT (MM)	
00722	60 x 15	19-A
00723	100 x 15	19-A

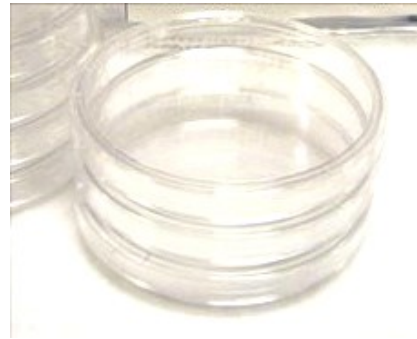

CATALOG # 00140 19-B

DISH, PETRI, CULTURE, PLASTIC

Sterile, disposable, top and bottom edges are squared off to provide a firm, secure grip. The skirt of the lid is flared just enough so that the bottom can be covered quickly after streaking. Because the edges are squared, not rounded, medium spreads evenly over the entire bottom of the dish. Three venting ribs built into the underside of the lid prevent build-up of condensation which would drip into the media. Made of clear polystyrene. Dish measures 100mm diameter, 15mm high.

Sold in packs of 25 sets.



DISH, WEIGHING, ALUMINUM

Use as disposable evaporating dishes, dust covers or balance pans. These dishes have no oil residue, and no vinyl coating to create contamination problems. Smooth flat bottom facilitates sample handling. Crimped-wall dishes feature increased rigidity and a large tab for sample numbers. Item 00126 sold in packs of 144, while item 00138 sold in packs of 100.

CATALOG #	CAPACITY	
00126	1.4 fl oz. (42ml)	14-A, 92-TOP
00138	2.2 fl oz. (65 mL)	14-A

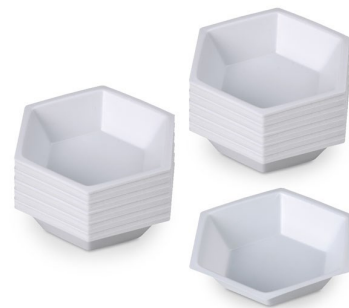

DISH, WEIGHING, POLYSTYRENE

For handling solids or liquids during weighing. The flexibility of polystyrene and the molded hexagonal design provide balance protection and safety. Dishes bend easily into pouring spouts to enable non-spill transfer. Won't react to most substances. Disposable dishes stack compactly for convenient storage and accessibility. Approximately 57 mL capacity.

CATALOG # 00308 14-A

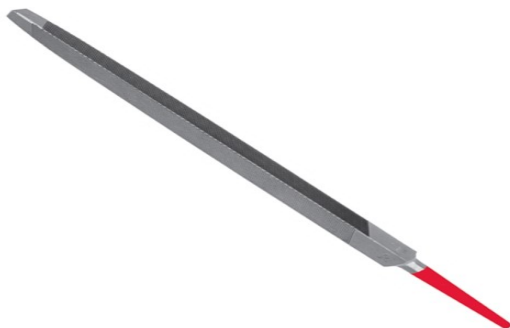

FILE, TRIANGULAR

Tapered. File is used to score glass tubing prior to cutting. Approximately 6" long.

CATALOG # 00153 90-B

FILM, PARAFIL M

Waterproof, flexible thermoplastic. Semi-transparent, almost colorless, and odorless. Supplied in 0.005" thickness. Adheres quickly and firmly to itself, covering culture tube or flask mouths and sealing petri dish edges. Excellent resistance to air, other gases, alcohol, common acids, and moderately concentrated alkalis. At 70° F, it stretches 200% and returns partially to its original size. At 180°F to 200°F, it softens enough to make an adhesive bond between papers, cloths, leathers, etc. Supplied in dispenser carton roll 4" wide and 125 feet long



CATALOG # 00220 16-B



FILM, SEAL-VIEW

Crystal-clear polyolefin-based sealing film outperforms the leading wax-like film, creating a long-lasting, leakproof seal while allowing a clear view of your samples. Tough, stretchable, and easy to apply without tearing. Service temperature range is -95° to +85°C (-139° to +185°F); won't crack at low temperatures. Offers superior resistance to solvents and acids; allows exchange of gases. Excellent for environmental analysis and life science applications; its biocompatibility has been determined by in vitro cytotoxicity tests using L929, MRC-5, and VERO cells. Also meets FDA standards for contact with food. Film thickness is 11.4 mL. Dispenser roll is 150' long.

CATALOG # 01235 94-A

FILTER PAPER, WHATMAN #1

A general purpose filter grade. Medium retention. It retains crystalline precipitates larger than 11µm, has an initial filtration speed of 40 seconds, a smooth surface of normal hardness. It is suitable for gravity or low suction filtration, separations of precipitates, soil analysis, seed testing, air pollution monitoring, and gas detection. Ash content per 12.5cm circle is 0.6mg. Pack of 100.

CATALOG #	DIAMETER (CM)	
00733	4.25	3-D
00734	5.5	3-D
00736	9.0	3-D
00737	11.0	3-D
00738	12.5	3-O
00739	15.0	3-O
00740	18.5	3-D



Pore size: 11 µm

FILTER PAPER, WHATMAN #4

The fastest qualitative grade. Ideal for filtrations that involve large particle precipitates, ferric hydroxide, aluminum hydroxide, or gelatinous precipitates. Very useful as a rapid filter for cleanup of biological fluids or organic extracts. Initial filtration speed is 12 seconds. Used in removal of dust in air. Surface is smooth. Normal hardness.

Pore size: 20 - 25 µm

CATALOG #	DIAMETER (CM)	
00759	4.25	3-K
00743	9.0	3-K
00744	11.0	3-K
00746	15.0	3-K



FILTER PAPER, WHATMAN #40

Double Acid washed. Ash content not exceeding 0.007%. Meets ASTM "ash content per circle" requirements. Laboratory standard for critical gravimetric analysis. Manufactured with demineralized water for high purity. Most widely used general purpose gravimeter filter paper. Medium speed and retention (8um); rough surface. Used for calcium oxalate, silica in steel and well-digested barium sulfate; as a high purity filter in the collection of trace elements and radionuclides in the atmosphere. Used as a support for x-ray fluorescence and as a sample carrier for Shoeniger combustion.



CATALOG #	DIAMETER	
00420	11.0 CM	3-J

Pore size: 8 um

FILTER PAPER, WHATMAN #42

The most retentive of the ashless grades, suitable for filtrating fine crystalline precipitates (2.5um particle retention). Suitable for precipitates that are ordinarily difficult to filter. Acid Wash, Ash content 0.007%. Highly retentive for very fine analytical precipitates, such as barium sulfate or metastannic acid. Recommended for use with vacuum. Suitable for gravity or low suction filtration.

CATALOG #	DIAMETER (CM)	
00748	5.5	3-E
00749	7.0	3-E
00750	9.0	3-E

Pore size: 2.5 um



FAST PES BOTTLE TOP FILTER

500 mL volume. Has a membrane diameter of 75 mm, a neck size of 45 mm, and a pore size of 0.2 µg

CATALOG # 00588 81-TOP



FILTER RECEIVER, FOR PES FILTER

1000 mL capacity, designed to hold bottle top filter above (item # 00588)

CATALOG # 00597 82-TOP

CATALOG #	ST NECK JOINT	CAPACITY (ML.)	
00761	14/20	5	34-A
00762	14/20	10	34-A
00764	14/20	25	34-A
00765	14/20	50	34-B
00766	14/20	100	34-B
00767	14/20	250	34-C

00768	19/22	25	35-C
00769	19/22	50	35-C
00770	19/22	100	35-C
00771	19/22	250	35-C
00772	19/22	500	35-C

00773	24/40	50	36-B
00774	24/40	100	36-B
00775	24/40	250	36-C
00776	24/40	500	36-D

FLASK, BOILING, STANDARD TAPER JOINT

Boiling, with standard taper inner joint. Short neck. Smaller sizes are pear shaped while all others are round bottom.



**FLASK, DISTILLING, 2-NECK**

Two necks, angle type, both joints are the same outer 14/20 Standard Taper joints.

CATALOG #	CAPACITY	
00783	100 mL	34-C

FLASK, DISTILLING, 3-NECK

Round bottom, heavy wall three-neck flask with standard taper outer joints on the center neck and 20° angled side necks.

CATALOG #	S.T. JOINT	CAPACITY (ML)	
00784	14/20	50	34-B



FLASK, ERLLENMEYER, NARROW MOUTH

For general laboratory use. Flasks are versatile and economic, with a thick-walled body and long, tapered outside contour to minimize chipping. Tops are tooled with a rounded finish and reinforced for maximum mechanical strength. Durable white ceramic enamel scales indicate approximate volumes for measuring and mixing.

Meets ASTM Specification E1404, Type I, Class 1 requirements.



CATALOG #	CAPACITY (ML)	
00790	25	29-TOP
00791	50	29-TOP
00792	125	29-TOP
00793	250	29-TOP
00794	500	29-A
00795	1000	29-B
00797	2000	29-B

FLASK, ERLLENMEYER, VACUUM FILTERING

Similar to Erlenmeyer flasks above. These flasks have tubulation with an O.D. of 10mm.

CATALOG #	CAPACITY	
00801	125 mL	29-C
00802	250 mL	29-C
00803	500 mL	29-C
00804	1000 mL	29-C

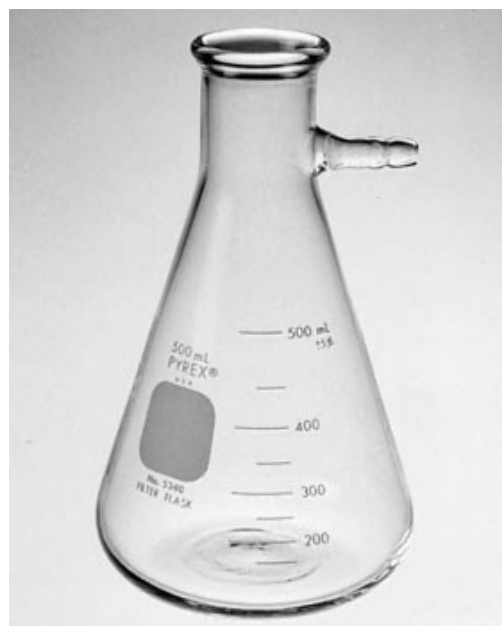

FLASK, VACUUM, DEWAR

These flasks are manufactured for use with liquid nitrogen (LN₂) and ideal for use with liquid gases. A strong, light-weight aluminum shield encases the flask from cover to base and also serves as a stand, lowering the center of gravity and providing stability. Accidental breakage from dropping or other impact is reduced.

The glass container is attached firmly to the interior of the aluminum case. Flasks are completely silvered and evacuated, ready for use. Most flasks come with a resilient plastic mesh cover, which provides a firm grip and a cushion against bumping to increase protection.



CATALOG #	CAPACITY	
00814	350 mL	96-D
00816	1000 mL	96-D
00820	850 mL (LOW FORM)	96-E

FLASK, VOLUMETRIC

Class A flasks are calibrated at 20°C. With sharp, permanent graduation line and white inscriptions. Flask body is machine blown with sealed heavy-tubing neck. Includes interchangeable Standard Taper stopper.

CATALOG #	CAPACITY (ML)	ST #	
00805	10	9	27-B
00806	25	9	27-B
00808	100	13	27-B
00810	250	16	27-B
00811	500	19	27-C
00812	1000	22	27-C



FLUOROMETER CELLS, ACRYLIC, DISPOSABLE

UV Fluorimeter Disposable Acrylic Cuvettes, 3.5 mL volume, 10mm light path. Packaged in trays of 100, but sold individually. 280-900 nanometers.



CATALOG # 00605 3-A

FORCEPS, BLUNT POINT, CURVED

Stainless steel. Medium curved. Serrated points



CATALOG # 00446 3-G

FORCEPS, BLUNT POINT, STRAIGHT

Student forceps. Handle chemicals safely. Stainless steel. Durable. Resist rusting. Straight type. 5" (12.7 cm) long.



CATALOG # 00447 3-G



FORCEPS, BLUNT POINT, STRAIGHT, PLASTIC

Serrated forcep tips improve grip. Manufactured from molded polypropylene plastic. Steam autoclavable at 121 C (250 F) for sterile applications. 5" (12.7 cm) long.

CATALOG # 00449 3-G

FUNNEL, STEMLESS

Pyrex funnel, stemless. 75mm large diameter, 60° angle bowl. Molded construction with bottom ground flat and beaded rim.

CATALOG # 00176 82-A

**FUNNEL, BUCHNER, POLYPROPYLENE**

Sturdy two-piece Buchner funnel consists of cup with perforated plate and funnel. Components separate easily for cleaning. All sizes are made entirely of polypropylene. Autoclavable to 135°C (275°F)

CATALOG #	INSIDE DIAMETER (MM)	FITS PAPER OF DIAMETER (MM)	
00833	59	55	81-B
00835	130	110	81-B

**FUNNEL, BUCHNER, PORCELAIN**

One-piece funnel with fixed perforated filter plate. Completely glazed except for rims. Highly resistant to chemical attack. Autoclavable.

CATALOG #	PLATE DIAMETER (MM)	DIAMETER OF PERF. AREA (MM)	
00830	43	32	3-G

FUNNEL, BUCHNER, FRITTED DISC.

Fritted disc funnels. These funnels are especially useful where filter paper would be attacked by the material being filtered. The disc should not be subjected to pressure in excess of 1 atmosphere. The top edge is beaded.



CATALOG #	CAPACITY (ML)	POROSITY	DIAMETER OF DISC (MM)	STEM LENGTH (MM)	
00836	2	MEDIUM	10	31	96-B
00837	2	COARSE	10	31	96-B
00839	15	COARSE	20	75	96-B
00840	30	MEDIUM	30	75	96-C

Fine Porosity - 4 - 5.5 microns - Filtration of Fine precipitates. Mercury valve. Extraction apparatus.

Medium Porosity - 10 - 15 microns - Filtration of crystalline precipitates. Extraction apparatus. Extraction of "floaters from distilled water.

Coarse Porosity - 40 - 60 microns - Filtration of coarse materials. Gas dispersion, gas washing, gas absorption. Mercury filtration. Extraction apparatus.

**FUNNEL, GLASS, 60°**

Made from hand blown blanks. Approximate 60° angle bowl. Heavy uniform walls, beaded reinforced rims, fire-polished ends.

CATALOG #	TOP DIAMETER (MM)	STEM LENGTH (MM)	
00823	90	97	3-G
00821	122	150	82-B

FUNNEL, GLASS, 60°, FLUTED

Bowl is 60° angle with depressed inside flutings to increase filtering speed. Strong, beaded rim. Can be used in flasks or tubes without racks.

CATALOG #	TOP DIAMETER (MM)	STEM LENGTH (MM)	
00178	65	65	82-B
00179	65	150	3-G

**FUNNEL, POWDER, GLASS**

Fire polished edges reduce chipping. Short wide stems. Stem length is 35 mm.

CATALOG #	TOP DIAMETER (MM)	
01117	60	82-A
01118	100	82-A





FUNNEL, PORCELAIN, HIRSCH

Coors porcelain Hirsch-Type funnels with perforated plate. Cone-shaped with fixed perforated plate. Glazed inside and outside except for rim.

CATALOG #	TOP DIAMETER	PLATE DIAMETER	DIAMETER OF PERF AREA	
00851	42	11.5	8.5	81-C
00852	55	31	21	81-C

FUNNEL, PLASTIC



Heavy-duty. Ideal for vacuum filtration. Not recommended for exposure over 80°C (176°F). 00826 and 00827 are ribbed and have tab handles. Funnels 00824 and 00824 are polypropylene, 00826 is low density polyethylene, and 00827 is high density polyethylene.

CATALOG #	TOP DIAMETER (MM)	STEM LENGTH (MM)	
00824	34	52	32-A
00825	87	23	32-A
00826	101	74	32-A
00827	201	89	32-A

FUNNEL, POWDER, POLYPROPYLENE



Parallel stem minimizes bridging of powder, external ribbing prevents air locks. Durable polypropylene. Autoclavable.

CATALOG #	TOP DIAMETER (MM)	
00828	80	32-A
00829	100	32-A

FUNNEL, ADDITION, GRADUATED

Cylindrical funnel has a pressure equalizing line and a PTFE stopcock. Graduations to the stopcock are numbered both up and down. All joints on funnel are Standard Taper.

CATALOG #	CAPACITY (ML)	JOINT SIZE	HEIGHT	
00870	25	14/20	200mm	34-D

**FUNNEL, SEPARATOR, PEAR-SHAPED, GLASS STOPCOCK**

Funnel is supplied with a Standard Taper ground glass stopcock and stopper. Lower stems have an I.D. large enough that a column of liquid will “break” with the stopcock closed, thereby giving a more complete separation and eliminating the necessity of emptying the funnel. Designed from ASTM Specification E1096, Type 4 requirements.

CATALOG #	CAPACITY (ML)	STOPCOCK SIZE	STOPPER SIZE	
00861	250	4	22	80-C

**FUNNEL, SEPARATOR, PEAR-SHAPED, PTFE STOPCOCK**

Funnel is supplied with a Standard Taper ground glass stopper and a PTFE stopcock. Lower stems have an I.D. large enough that a column of liquid will “break” with the stopcock closed, thereby giving more complete separation and eliminating the necessity of emptying the funnel. Designed from ASTM Specification E1096, Type 4 requirements.

CATALOG #	CAPACITY (ML)	STOPCOCK SIZE	STOPPER SIZE	
01148	125	2	22	34-F
01149	250	4	22	34-F
01150	500	4	27	80-B



FUNNEL, SEPARATORY, PEAR SHAPED, ADDITION

Funnel supplied with a PTFE stopcock. Lower stems have an I.D. large enough that a column of liquid will “break” with the stopcock closed, thereby giving a more complete separation and eliminating the need of emptying the funnel. Both the neck and the delivery stem have a Standard Taper medium length joint. With a drip tip.



CATALOG #	CAPACITY (ML)	STEM JOINT	STOPPER SIZE
00864	125	19/22	2 35-D

GLOVE, KIMTECH, CO-POLYMER

Ideal for any cleanroom or electrostatic-sensitive operation. Package of 100. 12” G5 Pure. Ambidextrous.



CATALOG #	SIZE
01345	SMALL 70-B
01346	MEDIUM 70-B
01347	LARGE 70-B
01348	X-LARGE 70-C



GLOVE, LATEX, POWDER FREE

Flexible, durable and comfortable. Nonsterile. Ideal for medical, laboratory, and industrial applications. Surgical quality natural rubber latex. Contain no fillers or extenders that degrade elasticity and no thiurams or thiazoles, know chemical sensitizers. Puncture and tear resistant.

Extra strong rolled cuffs make donning easier and prevents roll-down. Textured fingers for firm grip. Provide watertight barrier for protection from infectious materials. 100% visually inspected. Ambidextrous. Single-use. White. Length, 9 1/2” (24cm). Gauge 6 mil.

Manufactured in compliance with the FDA’s current Good Manufacturing Practice (cGMP). Powder free gloves are suitable for class MM4.5 (Class 1000) or above cleanrooms.

CATALOG #	SIZE
00199	SMALL 11-C
00203	MEDIUM 11-C
00202	LARGE 11-C
00198	X-LARGE 69-C

GLOVE, NEOPRENE

Double dipped. Feature a blue neoprene blend over yellow natural latex for reinforced strength, plus an embossed grip on the palm and fingers. Oil and chemical resistant. Cotton flock lining enhances user comfort. Two color design provides a safety assurance wear indicator. Comply with 21CFR170-199. 13" (33cm) length. 28mil thickness.

**CATALOG #**

00878

SIZE

MEDIUM (8—8.5)

22-A

GLOVE, BLUE, NITRILE

Powder free nitrile examination gloves. Ambidextrous, Non-sterile, beaded cuff. Compliant with FDA regulations for food contact. 9.5" length. Thickness: 4.3mil (palm), 3.9mil (finger). Meets ASTM D6319, US QSR/FDA 510(K), AQL 1.5.

CATALOG #

01274

01275

01276

01277

SIZE

SMALL

MEDIUM

LARGE

X-LARGE

10-C

10-A

10-B

10-C

**KIMBERLY-CLARK PURPLE NITRILE**

Textured fingertips and beaded cuff. Ambidextrous and powder-free. Regular gloves have a 9.5" length, while long-cuff are 12". Thickness: 5.9mil (finger), 4.7mil (palm), 3.5mil (cuff). Exceed ASTM standard for critical defects. Meets Chemotherapy Permeation Testing per ASTM D6978-05.

CATALOG #

01341

01342

01343

01344

01255

SIZE

SMALL

MEDIUM

LARGE

X LARGE

X-SMALL (LONG-CUFF)

12-C

12-A

12-B

12-C

69-C



GLOVE, TRIPLE-LAYER, MICROFLEX SYNTHETIC COMPOSITE

The 93-260 glove's unique, triple-layer construction features a soft interior specifically designed to enable easy donning and doffing. Its flexible middle layer delivers maximum protection against acids and bases, while the durable exterior delivers maximum protection against organic solvents. Made of neoprene and nitrile. Powder-free, ambidextrous, beaded cuff, and textured. Disposable. Sold in boxes of 50 gloves. Length: 11.8". Thickness: 7.8mil. Compliant with ASTM D3577, TYPE II, PPE 89/686, EN 420, 388 & 374 CATEGORY III.



CATALOG #	SIZE	
01441	SMALL	11-B
01442	MEDIUM	11-A
01443	LARGE	11-A
01444	X LARGE	11-B

GLOVES, SILVER SHIELD, LAMINATE

Length: ~15" (38cm). Gauge, 4 mil. Made from Norfoil, a light weight, flexible laminate which resists permeation and breakthrough by more toxic or hazardous chemicals than any other glove material. Resistant to aromatic, chlorinated, oxygenated, and aliphatic solvents, as well as acids and bases. Disposable. Ambidextrous. Can be used as an inner glove for extra protection against tears or punctures.



CATALOG #	SIZE	
00195	MEDIUM	22-A
00196	LARGE	22-A

HEAD PROTECTION, HARDHAT

Bullard S61 series. Hat is constructed of high-density polyethylene. Four point suspension with Flex-Gear ratchet design. Includes a brow pad made of a synthetic terry-like fabric that's absorbent and fast drying. Meets ANSI/ISEA Z89.1, Type I, Class E and G requirements. Hard hat includes a rain trough to channel away rain, snow and condensation, making it appropriate for work where precipitation is a problem. Includes accessory slots for attachments. Available in yellow, white, blue, gray, green, and orange.



HARD HAT CATALOG #	01233	94-D
--------------------	-------	------

HEARING PROTECTION, EARPLUGS

Bell shape delivers maximum in-ear comfort. Contoured design easier to insert, resists tendency to back-out of ear canal. Polyurethane foam enhances comfort, especially for long-term wear. Smooth, soil-resistant closed cell-foam skin prevents dirt build-up.

33dB NRR

Attenuation tested in accordance with ANSI™ S3.19-1974.



CORDED CATALOG #	01111	17-A
UNCORDED CATALOG #	01110	17-A



HEATING MANTLE, HEMISPHERICAL

Hemispherical mantles for spherical flasks. Fabricated entirely of glass fabrics. Covers only bottom half of flask, allowing full view of contents. Use where upper area of flask does not require heat. With 2-wire cord and plug. Maximum temperature : 450 °C. For 115 volts.

CATALOG #	SIZE (ML)	
00432	500	95-A

HEATING MANTLE, SPHERICAL

Designed with elliptical opening in top for one, two, or three-necked flasks; upper and lower halves joined together with zipper. The 250 and 500 mL sizes provide a single nichrome heating circuit in lower half only. The 1000 and 2000 mL sizes provide separate heating circuits in each half. With two-wire cord and plug. For 115 volts. Maximum temp.: 450 °C.

CATALOG #	SIZE (ML)	
00205	1000	95-A



SPILL KIT, MERCURY

EconoMercury Spill Kit. Everything you need to handle small mercury cleanups in an economical, portable-size kit. Kit includes: One Hg Absorb jar, two Hg Absorb sponges, one 500gm container of Hg Absorb powder. Compact kit conveniently stores at your workstation or in a drawer. Always ready to use.

CATALOG #		
00002		4-D



LABEL TAPE

Adheres to any clean surface, including Teflon® fluoropolymer resin-coated materials, and peels off without leaving a sticky residue. Pencil, ball-point pen, or solvent ink marker remain legible under the most demanding laboratory conditions. Consists of colored paper with rubber resin adhesive that resists moisture and most solvents. Suited for use in low-temperature applications.



CATALOG #	SIZE	COLOR	
01246	13 m (14 yds.)	ORANGE	3-I
01247	13 m (14 yds.)	YELLOW	3-I

LABELS, SELF-ADHESIVE



Stick to almost any surface without moistening. Easily marked with pencil, pen, ball point or felt-tip marker. Latex-impregnated paper with adhesive backing. Conforms to rounded surfaces. Easily removed in one piece without leaving residue. Pressure sensitive. Labels have red border.

CATALOG #	SIZE	SOLD BY:	
00211	30 X 25 MM	ROLL/900	3-C
00428	41 X 32 MM	ROLL/720	3-B

LENS CLEANER, PAPER

For cleaning glass lenses. Never scratches glass lenses, objectives, or other delicate surfaces. Doesn't become harsh; doesn't readily collect dust or grease. Virtually lint-free sheets are glued and bound in a booklet for easy removal. Supplied in booklet of 50 sheets.



CATALOG #		
00411		3-S



SNOOP, LIQUID LEAK DETECTOR

Allows easy detection of gas leaks. Noncorrosive and nonflammable.

CATALOG #		
00337		4-A



LIGHTER, GAS, SHURLITE

Safety gas lighter. For lighting gas burners without using matches. Activated by squeezing a spring metal hand grip. The lighter produces a spark by means of a flint tip traveling across a metal file. Hood protects file and traps gas to help ignition.

CATALOG # 00212 3-U

MAILING TUBE, CARDBOARD

For bottles and samples. Heavy, waxed cardboard containers have metal bottoms and screw caps. Fully assembled with corrugated pads in cover and bottom of tube.



CATALOG #	DIAMETER X HEIGHT	
00890	5.7 x 14 cm (2.25 x 5.5")	19-TOP

MORTAR & PESTLE

Porcelain mortar is glazed outside except for bottom. Rough inside. Ideal for pharmaceutical applications. Porcelain pestle is glazed to grinding surface and oversized for hand comfort.



CATALOG #	ITEM	SIZE	
00893	MORTAR	47 x 70 mm	21-A
00894	PESTLE	114 mm	21-A

MARKING PENCILS

Berol, high melting point, writes on glass and porcelain. Marks remain legible up to 204°C (400°F). Marks are moisture resistant and stable in presence of most reagents. Core enclosed in hard roller paper. Unwind as needed.

CATALOG #	COLOR	
00895	RED	3-P
00897	BLACK	3-P



MICROSCOPE SLIDE, COVER SLIPS

Thermo Scientific™ Cover Slips protect assay preparations from chemical attack. Made of D 263 M colorless borosilicate glass. Made for use in medicine, biology, and research. Superior quality. Packed to prevent sticking. Uniform, distortion free surface. Comes in 1 oz packages, containing approximately 100 slides.

CATALOG #	SIZE (MM)	THICKNESS (MM)	
01152	18 X 18	.13 - .17	9-B
01153	22 X 22	.13 - .17	9-B
01154	18 X 18	.18 - .25	9-B
01155	22 X 22	.18 - .25	9-B



MICROSCOPE SLIDES, PLAIN GLASS

Cost-effective slides for general-purpose applications. Plain microscope slides. Clearest possible optics for unmatched transparency and absence of glass color tint. Precision ground edges on all 4 sides. Size 3" by 1". 1.0mm thickness

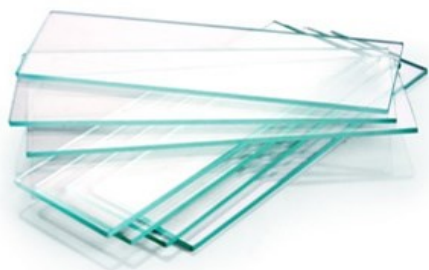

CATALOG #	00032	3-S
-----------	-------	-----

PH, BUFFER CAPSULES

Powdered ingredients make precision buffers ($\pm 0.02\text{pH}$ at 25°C); come in capsules, Just dissolve in 100ml distilled water. Capsules are color coded: red orange for pH4, green for pH7, and blue for pH10.



CATALOG #	PH	
00983	4	5-A
00984	7	5-A
00985	10	5-A

PH Testing Paper

Sold in vials of 100 strips of paper, each strip covers the full range of 0 to 14 pH units. A color change will occur for each pH unit and a color matching chart is affixed to the side of the vial. Two charts are provided on each vial, i.e., 1-6 pH and 7-14 pH. 100 strips per vial. Can be used as a more flexible substitute for traditional litmus paper.



CATALOG #	00018	8-A
-----------	-------	-----

PIPET, DROPING, DISPOSABLE

Low density polyethylene. Molded in one piece. Non-wetting material, tapered tip, and bellows-type bulb provide excellent drop formation. Delivers 30 to 35 drops per mL. Safe and economical. Visible liquid level.



CATALOG #	00453	20-Top
-----------	-------	--------

PIPET, DROPPER, BARNES BOTTLE

Replacement pipet for 00035 Barnes bottle. With stopper-shaped rubber bulb.



CATALOG # 00351 91-C

PIPET, DROPPER, 2.4 mL

These unbreakable all-in-one graduated transfer pipets eliminate the hazard of broken glass and exposure to infectious materials. Molded from see-through low density polyethylene, pipets are inert to biological fluids and most acids, and can be sealed and refrigerated. The low-affinity surface reduces the loss of cells and valuable proteins due to binding. Ideal for quick, safe transfer of fluids. Transfer pipets can be gas sterilized.

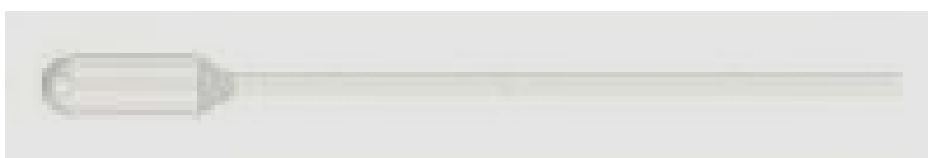

CATALOG # 00452 21-Top



PIPET, MEDICINE DROPPER

Inexpensive pipets with straight tip and tapered rubber bulb. Approximately 70 mm long. Capacity 2 mL.

CATALOG # 00227 91-C



PIPET, MICROCAPILLARY, DISPOSABLE

Calibrated to contain. Pipets are 5 inches long with a single black capacity ring. Clean and ready to use. Made of soda lime glass in compliance with ASTM Specification E438, Type II glass requirements. Filling is easy. Capillary action draws the fluid into the tube. To dispense, simply cover the hole on the rubber bulb and squeeze. Packed in easy-open cylinders for convenient dispensing. Cylinder contains 250 pipets and one pipet device. Design from ASTM Specification E672 requirements. 5 microliter capacity. 1% tolerance.

CATALOG # 01234 17-B

PIPET, MICROCAP

Microcaps are ingeniously simple... in concept and in use. These precision-bore glass capillary tubes are cut to predetermined lengths, so that each capillary tube will hold a known volume of fluid when filled

Drummond Microcaps are so inexpensive that it is almost always practical to dispose of the tube after use.

Filling is simple. Capillary action-not externally applied suction-draws the fluid into the tube. To dispense the fluid, simply squeeze the bulb. No unusual skills or training is required. Immediate, professional results. Ideal for spotting preadsorbent TLC plates.

Supplied in packages containing 1 bulb assembly and 1 dispenser vial of 100 micropipettes.



CATALOG #	CAPACITY (MICROLITER)	LENGTH	
01004	1	32MM	94-B
01005	5	32MM	94-B
01006	10	41MM	94-B

PIPET, DISPOSABLE, PASTEUR

Soda-Lime glass. Ideal for transferring samples to sample cups and for drop counting, thanks to uniform bore. Tip openings range from 0.80 to 1.20mm. Conform to government specifications in design, style. Top and tip free of sharp edges. Can be cotton plugged (plugs not included). Sold in packs of 250.

CATALOG #	SIZE	
00224	5 3/4"	20-A
00225	9"	20-A

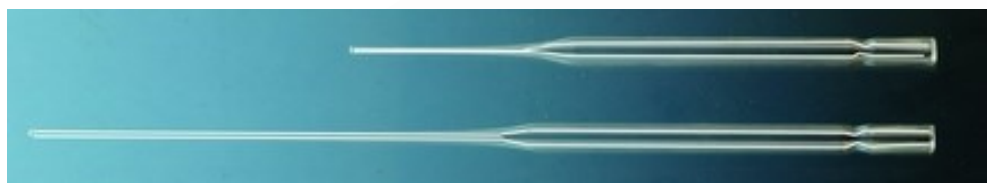

PIPET, GRADUATED, MOHR

White graduations. Pipets are carefully calibrated and a durable white enamel is bonded to the glass. Calibrated to deliver.

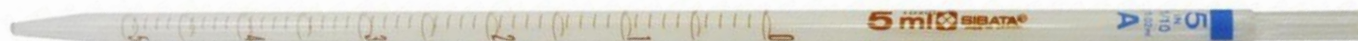

CATALOG #	CAPACITY (ML)	
00900	1	76-A
00901	2	76-A
00902	5	76-A
00903	10	76-A
00904	25	76-A

PIPET, VOLUMETRIC

Calibrated to deliver. These large tip pipets are the most widely used volumetric pipets for general laboratory work. Large tip openings permit you to deliver contents at a faster rate than that approved for precision pipets.

CATALOG #	CAPACITY (ML)	
00905	1	76-B
00906	2	76-B
00907	5	76-B
00908	10	76-C
00909	20	76-B
00910	25	76-C
00911	50	76-D
00912	100	76-D



PIPET TIPS, RELOAD DECK, FISHER SureOne™

Fisherbrand™ SureOne™ Reload system micropoint universal-fit pipet tips. All racked nonsterile tips are certified free of RNase, DNase, and DNA. Flush Fit Inserts sit flush with rack, allowing easy multichannel pipetting. Notched clasp props lid open for autoclave venting. Inserts are easy to place onto and remove from rack, clip on for a secure fit. Indented insert holes inhibit tip movement, stabilizing them for multichannel work. Multi-channel design; all inserts are 96 well format Robust non-pliable design provides secure seals on every tip.

CATALOG #	VOLUME	
01176	0.1 - 10 uL	26-B
01177	1 - 200 uL	26-C
01178	100 - 1250 uL	26-B



RACK, SUPPORT / DRYER, POLYPROPYLENE

With cylindrical wells for tubes, vials, bottles, centrifuge shields, etc. Of stable one-piece construction. The 00982 size rack takes 50ml centrifuge tubes and shields, and 1 oz. (30ml) dropping bottles.



CATALOG #	00981
NUMBER OF WELLS	12
NUMBER OF PINS	5
I.D. OF WELLS (MM)	20.5
DEPTH OF WELLS (MM)	52
RACK LENGTH (MM)	203
	16-A

RESPIRATOR, N95, DISPOSABLE

Requires approval from EHS before purchase is permitted.

The self-supporting filter cup design of this mask provides economy and comfort in nuisance level dusts such as alfalfa, pollen, calcium carbonate, gypsum limestone, and many other nontoxic particulates.

Not for toxic or hazardous particulates.



CATALOG #	00150	90-A
------------------	-------	------

RULER, LINEAR, METER STICK

Hardwood, scaled on one face in cm with 1 mm graduations; on the other side, inches with 1/8 graduations.

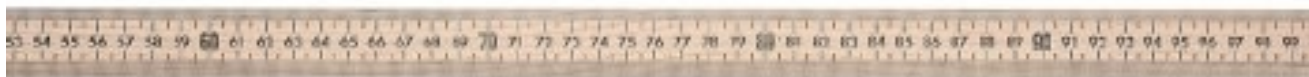

CATALOG #	00217	78-B
------------------	-------	------

Goggle Safety

What Do the ANSI Standards Really Mean

An important obligation of a responsible science teacher is to provide students with safe, appropriate eye protection. As you compare the wide array of goggles and safety glasses, you often see the phrase “Meets ANSI Z87.1 Standards”. In the Flinn Scientific Catalog/Reference Manual we list several eyewear styles, all of which meet the ANSI standard. Obviously, there must be more to choosing safe eyewear than merely picking any style which meets this standard. To choose the most suitable eyewear for yourself and your students it is helpful to understand ANSI and its relationship to regulations concerning school laboratories.

What Is ANSI Z87.1

The American National Standards Institute (ANSI) is a non-profit association which publishes standards covering a broad range of equipment and industries. The complete title of the current ANSI document pertaining to eyewear is American National Standard Practice for Occupational and Face Protection, ANSI Z87.1—2003. This document includes standards for several different styles of safety eyewear ranging from eyeglass-type spectacles to heavy-duty welding helmets. Each style has its own standards. ANSI’s objective is to provide basic performance requirements for eye and face protection. For example, the tests listed below are two of the standards for removable goggle lenses:

- Lenses shall resist impact from a 25.4 mm diameter steel ball dropped from 127 cm.
- Lenses shall resist penetration from a projectile weighing 44.2 g dropped from 127 cm.

For clarification of the relevance of these standards to your choice of laboratory eyewear it is helpful to understand more about ANSI and Z87.1.

- ANSI is not a federal agency. As an independent association it is not involved in establishing or enforcing the OSHA Laboratory Standard.

ANSI does not test, inspect or approve eyewear. The eye protection manufacturer can choose to contract an independent testing facility to conduct tests to determine if their products meet ANSI standards.

- There are important factors that are difficult to measure and are not covered in Z87.1 that must be considered when choosing eyewear. Among these are durability, comfort, anti-fog performance, and chemical splash protection.

Keep in mind that not all eyewear is created equal. There are a lot of cheaply made goggles on the market that will not survive even one semester. How safe are goggles that meet ANSI standards, but will be left in a desk drawer, unworn, because they are broken or uncomfortable?

- Eyewear should fit comfortably and securely. Try different styles and sizes to find the right fit.
- Chemical splash goggles should have a soft, pliable flange which seals around the eyes. The hard plastic edge on models lacking a flange becomes extremely uncomfortable.
- The availability of replacement parts (headbands, lenses, vent covers) is a real cost saving advantage.
- Anti-fog performance is affected by temperature and humidity. Experiment with different eyewear styles and features (vents and fog-free lenses) to find the best eyewear for your application.

Chemical Splash Protection

Just because eyewear meets Z87.1 standards does not necessarily mean it provides adequate protection from the dangers of splashed chemicals. Eyewear that does not provide a complete, snug seal around the eyes may be fine for some activities but not when using hazardous chemicals. When vent openings are provided on splash goggles, the vents should be indirect, with covers and/or baffles preventing straight-line passage of liquids into the goggles.

The Choice Is Up To You

As a responsible science teacher, you must select eyewear which provides you and your students the most suitable protection from the hazards involved in your laboratory activities. The following regulations address the role of the teacher’s judgment in selecting suitable eye protection:

Basic Recommendations

As you ponder which type of protective eyewear to purchase, or whether eye protection is needed at all, keep the following suggestions in mind:

- Will you be using heat, glassware or chemicals in the lab? If so, it is a good basic policy to use protective eyewear.
- Chemical splash goggles designed to provide full coverage around the eyes should be worn whenever hazardous chemicals are used.
- The educational laboratory is a unique environment where each student is often surrounded by other students conducting experiments. Hazards could come from any direction. Protective eyewear should provide sufficient angular coverage.
- Face shields which provide added splash protection coverage should not be worn alone. Always wear the appropriate goggles or safety glasses underneath a face shield.

Conclusion

While ANSI has established many standards for a variety of protective eyewear, it does not provide specific standards for several factors important to the science teacher. Among those factors are durability, comfort, and chemical splash protection. It is the teacher’s responsibility to keep these factors in mind when selecting eyewear. As clearly stated in the Flinn Scientific Catalog/Reference Manual, “You, the instructor, should decide what type of eyewear your students must wear in every case.” The information and high quality eye and face protection Flinn provides will help you make an informed, responsible choice.

SAFETY, GOGGLES, UVEX, STEALTH

Sleek, low-profile design fits well with respirators, hardhats or welding helmets. Light weight body combines durable polypropylene frame and soft, flexible elastomer inner flange that seals comfortably—conforming gently to facial contours and providing superior splash protection. Exclusive 4C+ coating protects the polycarbonate lens against fogging, scratches, static dust and >99.9% of harmful UV rays.

Wraparound lens improves peripheral vision. Textured neoprene headband prevents slipping and features quick-adjust clips. Goggles meet **ANSI Z87.1-1989** standards.



CATALOG #

DESCRIPTION

00136

LIGHT GRAY/CHARCOAL B002 window



SAFETY, GOGGLES, ULTRAGUARD

Superior protection from flying particles. Adjustable venting keeps lens clear. AF-coated polycarbonate lens resists fogging, scratching, static, UV rays, and impact. Clear vinyl body features a soft pliable nosebridge for added comfort. Elastic band headband allows a secure fit. Front swivel attachment lets you position head strap where it is most comfortable. Fit over eyeglasses.

CATALOG #

00141

B002 window

Compliance: ANSI Z89.1-1989, CSA Z94.3-92

SAFETY, GLASSES/GOGGLES, VISORGOGS

Designed to protect your eyes from flying particles, and to protect eyesight as well, by protecting your eyes from overhead light, glare, and distortion—thus reducing eye strain and fatigue and increasing the safety and comfort of the wearer with full vision lenses that allow 100% unobstructed vision. Fits over eyeglasses, no struts or frame to obstruct vision. Increased impact strength, no fogging or pitting. Lightweight, cool, and comfortable.



Compliance: Z87.1 Standard

CATALOG #

00130

2-A, B002-window

SAFETY GLASSES, SMALL FRAME

These glasses have a clear anti-fog lens and are specifically sized for smaller faces. They offer excellent coverage with fewer gaps that help to keep out particulates and flying debris. Lightweight, slim frame design offers full-shift comfort and meets ANSI Z87.1-2003 standards. Polycarbonate lens absorbs 99.9% of UV.



CATALOG #	FRAME COLOR	LENS	
00158	TEAL	CLEAR	B002 window
00159	MOCHA	CLEAR	B002 window
00160	ROSE	CLEAR	B002 window

SAFETY GLASSES, VISITOR SPECS

Economical, reusable glasses serve as ANSI/OSHA accepted eyewear for workers or as visitor specs.

Wrap-around frame with contoured nosepiece for secure, comfortable fit. May be worn over most prescription eyewear. Polycarbonate lenses offer 99.9% UV protection. Brow bar fits snugly to forehead for extra protection. 145mm temples add life to regular visitor specs.



Compliance: ANSI Z87.1-1989. CSA Z94.3-1992 High Impact.

CATALOG # 00134 1-B,C

SAFETY GLASSES, OTHER

Various styles of simple safety glasses, ranging in frame style and lens

CATALOG #	FRAME COLOR	LENS	
00127	BLUE	CLEAR or TINTED	B002 window
00299	BLACK	CLEAR	B002 window
00129	BLACK	TINTED	B002 window
00302	CLEAR	CLEAR, HALF TINT, or FULL TINT	B002 window



00301 - SAFETY GLASS CORD

For holding up the glasses more comfortably. Black cord. Section B002 Window.

SAFETY, APPAREL, LAB COAT, DISPOSABLE

SMS lab coat. These durable, lightweight lab coats are appropriate for both men and women. They are designed to provide you with maximum coverage in a variety of plant and laboratory environments. Full-length coats feature convenient snap closures, three pockets, and knit cuffs. The SMS material is tear-resistant, low linting and retains body particulate fallout while protecting the wearer from dirt and severe stains. Lab coats resist chemical degradation and protect against certain bacteriological contamination.



CATALOG #	SIZE	
00039	SMALL	84-A
00036	MEDIUM	84-B,C,D
00037	LARGE	85-A,B,C
00038	X-LARGE	86-Top,A,B,C
00044	2X-LARGE	85-Top
00046	3X-LARGE	84-Top

SAFETY, APPAREL, LAB COAT, COTTON

Medline unisex knee length lab coat. Performance poplin blend: 80% polyester / 20% cotton. Five button front with chest pocket with pencil slot and two lower pouches. Side vent openings. 41" length. White.

CATALOG #	SIZE	
01250	X-SMALL	14-B
01251	SMALL	14-B
01252	MEDIUM	14-B
01253	LARGE	14-C
01254	X-LARGE	14-C





SAFETY, APPAREL, LAB COAT, FLAME RESISTANT

Bulwark Excel FR lab coats. Fabric EXCEL FR flame-resistant, 7 oz. (235 g/m²) 100% cotton. Button front closure, lapel collar, hemmed sleeve ends, side vent openings. One chest pocket and two hip pockets. ATPV 7.7 calories/cm². Meets the requirements specified in ASTM F2302-08 for labeling protective clothing as heat and flame resistant. Meets the performance requirements of NFPA 70E (2009 ed.) and ASTM F1506-08 and is acceptable for use in occupations covered by OSHA Final Rule 1910.269.

CATALOG #	SIZE	
01265	SMALL	15-A
01266	MEDIUM	15-A
01267	LARGE	15-B
01268	X-LARGE	15-B

SAFETY, BOTTLE CARRIER

Hold one 5 pint or 1 gallon (2.5 or 4L) bottle. Made of thick molded black rubber to safely cushion glass bottles. A circular cup in the bottom centers bottle in the carrier with 1" (2.5cm) space between wall and bottle. The integral molded handle provides secure, comfortable grip.



CATALOG #	00056	35-TOP
-----------	-------	--------



FACE COVER, FLAME RESISTANT

For better protection in flammable environments, these hi-vis fluorescent yellow coverings are the way to go. Made of 2-ply FR blended knit, they carry an ARC rating of 10-cal/cm | CAT 2, meets 70E. The inherently flame resistant material will not wash or wear out.

CATALOG #	00154
-----------	-------

SAFETY, BOTTLE CAP, PSI VENTED

This vented cap fits standard 4 liter solvent bottles. Contains Teflon liner with a small relief hole, designed to prevent overpressurization of the glass container. Recommended for any storage of piranha mixtures, or other materials that may generate internal pressure over time.

CATALOG # 01300 83-D



GLUE, DUCO CEMENT

General purpose cement. For wood, paper, cloth, porcelain, or similar materials. Transparent, waterproof, cellulose compound. Available in 1 oz. (30ml) tubes.

CATALOG # 00041 3-U

SILICONE ELASTOMER KIT, SYLGARD 184

A flowable, transparent encapsulant consisting of a base and a curing agent. Can be cured at room temperature, or faster with heat. Product has good dielectric properties, and can be used for many electrical or other applications. Has UL 94 V-1 flammability rating and is UL 746C Recognized.



CATALOG # 01650 7-B

SEALANT, SWAK THREAD SEAL, PTFE

Swagelok SWAK anaerobic pipe thread sealant is a resin containing methacrylic ester with PTFE particles. Swak has a minimum 24 hour cure time before pressurizing. It can with stand pressure up to 10 000 psig (689 bar) and temperatures -65 to 350 Degrees Fahrenheit (-53 to 176 Degrees Celcius). Swagelok SWAK pipe thread sealant must be stored at 45 to 85 Degrees Fahrenheit (7 to 29 Degrees Celcius) and has a 5 year shelf life. Once cured it resists vibration or shock, allows low breakaway torque for easy-to-break connections and will not shred or tear on assembly. Swagelok SWAK is not compatible with: plastic or valve components other than PTFE, Halogens, Freon, Pure Oxygen, Ozone, Hydrazine, Nitrogen dioxide, High concentrations of strong acids or bases, food, cosmetic, drug or water systems for human consumption or any system with hydrocarbon outgasing that affects performance. (1.69 oz tube)



CATALOG # 30158 Y-Top



SEALANT, TAPE, THREAD SEAL, PTFE

Lubricates and forms gaskets. Produces long-lasting seals, joints, and connections. Conforms to any shape or configuration. Leakproof, nonfreezing, self-lubricating, noncontaminating. Heat resistant and chemically inert. For use on reaction flasks, bottles, bell jars, desiccators, thermometers, stirrers, anaerobic culture jars, freeze-dry and vacuum applications.

1/2" wide x 50' long.

CATALOG # 00267 3-U

SEPTA, RUBBER, SERUM BOTTLE STOPPERS

Sleeve type. Plug is hollow to within a short distance of the top. Top is flanged, with sleeve-like extension which folds down over the neck of the bottle.

Diaphragm can be punctured readily with a syringe needle; puncture seals automatically after needle is withdrawn.

Sleeve holds stopper securely in positon during handling and prevents leakage and evaporation.



CATALOG #	USE	SIZE MM	
00917	5MM. NMR TUBES	4.5	3-V
00918	7MM O.D. GLASS TUBING	5	3-V
00919	8MM O.D. GLASS TUBING	6	3-V
00920	9MM O.D. GLASS TUBING	8	3-V
00921	S.T. 10/30 JOINTS	10	3-V
00922	S.T. 14/20 JOINTS	13	3-Q
00923	S.T. 19/22 JOINTS	15	3-L
00924	S.T. 24/40 JOINTS	24	3-F

SORBENT PAD

Polypropylene pad with universal fluid absorption capabilities. Each pad can absorb 25 oz of fluid, and measures 15 x 19 inches. Perforated down the middle for easy tearing when desired.

CATALOG # 01615 82-D

**SCOOPULA**

Dig out materials, core, and stir easily. Scoopula spatula minimizes spilling in handling small amounts of material. Works better than a regular spatula. More versatile. Curved shape, one pointed end, one blunt end lets you dig salts out of bottles, add small amounts to balance pans, core samples of dry materials, remove lids from containers, stir solutions, etc. Stainless steel is strong and won't rust. 6 inches long (15cm).

CATALOG # 00926 3-G

**SPATULA, MICROSPATULA, HANDI-HOLD**

Small, 3/4" Length X 0.2" Wide (19 x 4.8mm) spoon like stainless steel blade on spatula. Cushion-grip vinyl handle for easy holding. Total length is 5 1/2".

CATALOG # 00232 3-G



SPATULA, TAPERED END, MICRO

Stainless steel. One end tapered to 1/8" (3.2mm); one end rounded. Blades approximately 2" long(51mm), 5/16" wide (7.9mm) at widest part. Overall length of 7".

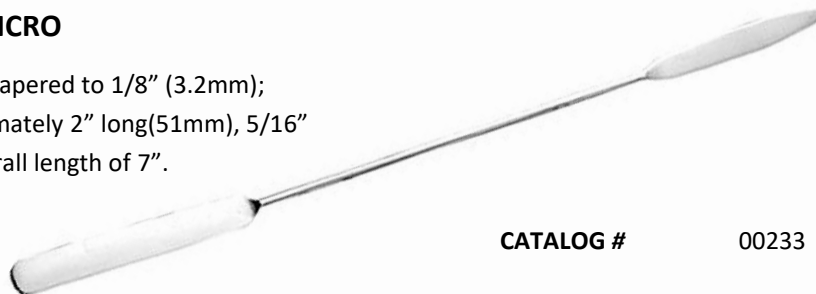

CATALOG # 00233 3-G

SPATULA, SPOONULA

For transferring crystalline materials. Spoon end is 1 1/4" L x 9/16" W (32 x 14mm). Spatula end is 2" L x 5/16" W (51 x 7.9mm). Ideal for crushing lumps, scraping, chopping, etc. Polished stainless steel.

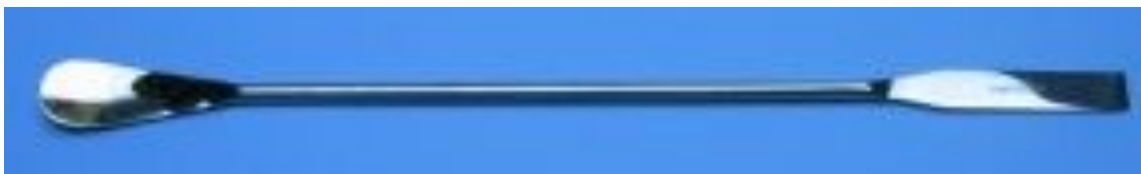

CATALOG # 00938 3-G

SPATULA, RUBBER POLICEMEN

Angled edge. Scrape precipitate from container. Hard rubber with angled edges. Use glass rod (sold separately) as a handle.



CATALOG # 00445 91-A

SPONGE, STAINLESS-STEEL

Excellent for cleaning stubborn spots from glassware and stainless-steel items. This sponge has no sharp edges to scratch glass or irritate hands. May be used with detergents.



CATALOG # 00239 3-U

STIRRING BARS, MAGNETIC

Teflon coated, leakproof, seamless, polished, and contains a permanent Alnico-V magnet. These octagonal stir bars have a molded pivot ring..

Item # 00929 is a flea micro spinbar, which is has no pivot ring.

CATALOG #	LENGTH	DIAMETER	
00929	10 MM	3 MM	3-A
00931	1/2" (13 MM)	5/16" (8 MM)	3-A
00932	1" (25 MM)	5/16" (8 MM)	3-A
00933	2" (51 MM)	5/16" (8 MM)	3-A
00934	3" (72 MM)	5/16" (8 MM)	3-A

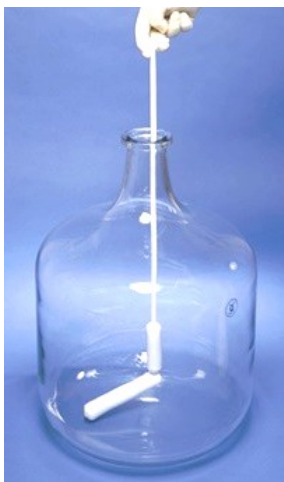
**STIRRING, STIR BAR RETRIEVER**

Polypropylene magnetic stir bar retrievers with Alnico-V magnet sealed in one end and hang-up ring on the other. Ideal pick-up rods, 3/8" diameter (9.5mm) x 12" (31mm) length.

CATALOG #		
00016		3-A

STIRRERS, GLASS STIRRING ROD

Soft glass stirring rod. With both ends rounded and fire polished. Approximately 8" long.

CATALOG #		
00244		3-T





STOPCOCK, 2-WAY, GLASS PLUG

Glass stopcocks feature interchangeable solid glass plugs. Closely controlled grinding techniques allow this general use stopcock to be used at pressures down to 10^{-4} torr (mm Hg) when correctly greased. For additional strength, sidearm seals are heavy and uniform.

CATALOG #	PLUG BORE	SIDE ARM O.D.	
00248	2 MM	8 MM	92-C

STOPCOCK, 2-WAY, TEFLON PLUG

The tapered Teflon plug fits into a micro finish barrel. Freezing problems are reduced and greasing is eliminated. The very fine threads on the plug and nut let you “feel” the position of the plug. Sidearm seals are heavy and strong for greater durability and easier handling.

CATALOG #	PLUG BORE	SIDE ARM O.D.	
00250	2 MM	8 MM	92-B

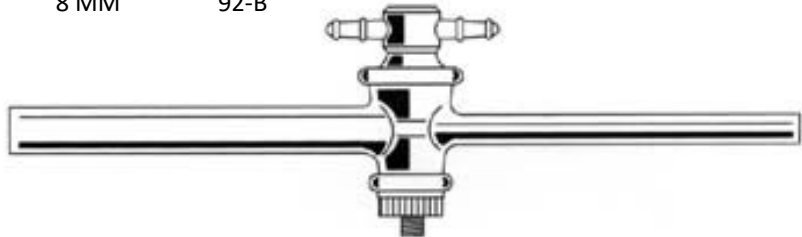

STOPPERS, CORK See heading: CORKS**STOPPER, PENNYHEAD**

Pyrex brand, solid. Pennyhead Standard Taper stoppers are generally used in flasks and separatory funnels.



CATALOG #	STOPPER NO.	APPROX LENGTH GROUND ZONE	
00969	13	14 MM	92-B
00970	16	15 MM	92-B
00971	19	17 MM	92-B
00973	27	21.5 MM	92-B

STOPPER, HDPE

These stoppers are made with closed bottoms, of linear high-density polyethylene to conform to Standard Taper stopper dimensions. The three unit rings on the base provide an efficient seal. The improved design fully protects the neck in the event of accidental tipping.

These stoppers may be used in place of the conventional Standard Taper flask stoppers above.

CATALOG #	STOPPER SIZE	
00977	27	92-A

STOPPER, STANDARD TAPER, GROUND JOINT

Hollow glass, closed at the bottom. Pennyhead. The first number of the Standard Taper designation indicates the approximate diameter in millimeters at the large end of the ground zone. The second number is the length of the ground zone.

CATALOG #	STANDARD TAPER	
00978	14/20	34-D
00979	19/22	35-D
00980	24/40	36-F



STOPPERS, RUBBER

Of specially selected grade, containing a high percentage of pure rubber. Stand up under the most trying laboratory conditions without hardening. Composition assures resiliency and pliability over a long period. They are low in free sulfur.



CATALOG #	SIZE	TOP (MM)	BOTTOM (MM)	LENGTH (MM)	
00943	00	15	10	25	68-D
00944	0	17	13	25	68-D
00945	1	19	14	25	68-D
00946	2	20	16	25	68-D
00947	3	24	18	25	68-D
00948	4	26	20	25	68-D
00949	5	27	23	25	68-D
00950	5 1/2	28	24	25	68-D
00951	6	32	26	25	68-D
00953	7	37	30	25	68-E
00954	8	41	33	25	68-E
00955	9	45	37	25	68-E
00956	10	50	42	25	68-E
00957	10 1/2	53	45	25	68-E
00958	11	56	48	25	68-E
00959	12	64	54	25	68-E
00960	13	68	58	25	68-E
00961	14	90	75	39	68-E

STOPPER, MICRO, RUBBER

For microchemical apparatus. Trim to fit any opening from 4mm to 12mm. Microsolid red rubber stoppers feature extremely high tensile modulus. Low durometer 40 ± 5 , low sulfur, low extractables. Top diameter, 12.7mm. Bottom diameter 3mm. Length, 50mm.



CATALOG # 00253 68-D

STOPWATCHE, DIGITAL, TRACEABLE

CATALOG #	00261
TIMING RANGE	Four channels 99 hours, 59 minutes, 59 seconds to one second
ACCURACY	0.01%
DISPLAY	6 DIGIT, 3/4" H(1.9CM) LCD
POWER SUPPLY	Silver-oxide battery (included)
DIMENSIONS	2 1/2" L X 2 3/4" W X 1/2" H (6.4 X 7 X 1.3CM)
SPECIAL FEATURES	Each channel works independently. Can count down, count up (stopwatch), time-out, and time of day. When zero is reached, alarm sounds and timer starts counting up.
LOCATION	3-P



SUPPORT RING, ZINC-PLATED STEEL

Extension support ring to be used in combination with support stand and clamp holder. A 12" length allows for adjustable distance from support. Rod has a diameter of 8 mm, and ring has an outer diameter of 10.2 cm.



CATALOG # 00481 93-D

SUPPORT, STAND, RECTANGULAR

Base made of Epoxyn solid epoxy resin for maximum resistance to chemicals and mechanical abuse. With 20" (51cm) long, nickel-plated steel support rod. Rod is 3/8" (9.5cm) in diameter. Base measures 5" x 8" (13 x 20cm).

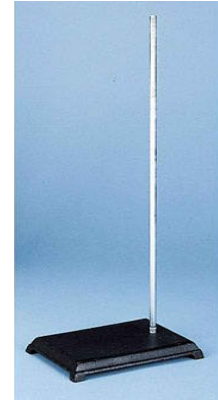

CATALOG # 00260 93-D

SUPPORT, TRIPOD

Iron ring is supported on three legs to eliminate rocking of support. 9" high. Ring I.D. is 3 3/16" (8.1cm). Ring O.D. is 5" (13cm).



CATALOG # 00264 78-A

SYRINGE, DISPOSABLE, WITH NEEDLE

Sterile disposable syringes. Autoclavable out of package. Syringes have 3cc capacity and are graduated in 1/10. Syringes come with detachable needle which has a length of 38.1mm (1.5").

CATALOG #	GAUGE	
00266	23	35-F
00268	25	35-F



SYRINGE, DISPOSABLE, WITHOUT NEEDLE

Packaged in individual sterile strip packs. Lubricated synthetic rubber piston allows for a smooth draw while a positive stop helps prevent accidental pullout. Bold graduations are easily read and resist wipe off. Syringes are ETO gas sterilized, latex and pyrogen free.



CATALOG #	CAPACITY	
01350	3 CC	35-E
01351	5 CC	35-E
01352	10 (12) CC	35-E

SYRINGE, HAMILTON, MICROLITER, 700 SERIES

Precision-bore glass syringes, individually fitted and assembled by hand. Plungers and barrels are not interchangeable; use each plunger only with the barrel to which it has been fitted. When using fixed needle (cemented needle) syringes for gas chromatography, the needle should be removed from the inlet and cleaned immediately after injection. To prevent barrel fracture due to differential expansion of metal and glass; avoid heating syringes above 50°C(122F). Do not autoclave fixed needle syringes; catalog number 00373 may be autoclaved if plunger is removed from barrel. All have needle point style No. 2.



CATALOG #	CAPACITY (UL)	NEEDLE TYPE	NEEDLE GAUGE	
00265	10	FIXED	26S	3-N
00373	10	REMOVABLE	26S	3-N
00359	NEEDLE ONLY FOR REMOVEABLE NEEDLE SYRINGE / 00373		2"	3-H

SYRINGE NEEDLE ONLY, REPLACEMENT, LUER-LOCK

Replacement needed for Luer-Lock style syringe tips. Made of stainless steel

CATALOG #	NEEDLE SIZE	
00381	18 GAUGE, 2"	3-M
00382	22 GAUGE, 1"	3-M
00425	23 GAUGE, 1.5"	3-M
00426	18 GAUGE, 1.5"	3-M

SYRINGE, TUBERCULIN

Reusable syringes with ground barrels and plungers, matched for precision. Annealed glass permits sterilization by boiling.

CATALOG #	CAPACITY (CC)	
00386	1	3-H



TEFLON SLEEVES, THIN

Sleeves are elongated cones of microthin (0.05mm) polytetrafluoroethylene film tapered to fit snugly around glass joints. Eliminate lubrication contamination along with frozen or leaking ground joints. Usable from -75° to $+250^{\circ}$ C (-103° to 482° F).

CATALOG #	STANDARD TAPER	
00331	14/35	3-T
00333	24/40	3-T



TEFLON SLEEVES, REUSABLE

Sturdy. Reusable. Knurled, reinforced gripping ring for easy and safe removal from Standard Taper ground joints. .4mm wall thickness.

CATALOG #	STANDARD TAPER	
01215	14/20	34-D
01216	24/40	36-A



TEST STRIPS, VARIOUS

CATALOG #	TEST PAPER	
00018	pH 0 - 14	8-A
00990	LITMUS BLUE	8-A
00991	LITMUS RED	8-A

Various test papers. All papers come in strips, 100 to a vial. Item 00018 includes color change chart for each full pH unit.



THERMOMETERS, VARIOUS, FAHRENHEIT & CELCIUS

ALL: 9-C

GENERAL-PURPOSE



Made in accordance with, and meeting accuracy requirements of, ANSI/SAMA Z236.1-1983. With permanently fused markings; non-roll fittings. Filled with organic liquid.

CATALOG #	SCALE RANGE	LENGTH (MM)	IMMERSION (MM)
00994	-10C to +260C (± 2°)	350	76
00992	0F to +230F (± 2°)	305	76
01107	-20C to +110C (± 2°)	300	76

THERMOMETER, DIGITAL, TRACEABLE

Easy to read hand held digital thermometers. Stainless-steel stem is chemically resistant to acids, bases, solvents and may be used to measure temperature of gases, food, and other semisolids. For use in cuvettes, soil, incubators, petroleum products, and food. Thermometers come with serial-numbered certificate indicating traceability to standards provided by NIST. With protective guard.

FEATURES: Traceable. Dual range; always reading; HOLD button freezes reading; updates every second; probe guard with pocket clip attaches to handle to extend length to 10 3/4" (27cm).

RANGE: -50C - +300C
-58F - +572F

RESOLUTION/ACCURACY: 0.1° from -20° to +200°, 1° outside this range/ +1.5°C

LCD DISPLAY: 1/4" H (6.4MM)

PROBE DIMENSIONS: 1/7 dia. X 3 1/2" L (3.6mm x 89mm)

OVERALL DIMENSIONS: 5/8 dia. X 7" L (1/6cm x 17.8cm)



CATALOG # 00719 91-A

TRAY, POLYETHYLENE

Injection molded of heavy-duty polyethylene material. Impervious to acids, fats, oils, and grease. Easy carry handles. Temperature range is 20°F—190°F. Color is gray. Comply with FDA regulations.

Overall dimensions: 20”L x 17”W x 5”H

CATALOG # 01000 16-A



TRAY, STERILIZING, POLYPROPYLENE

Steam autoclavable at 121°C. Smooth surface rounded corners for easy cleaning. Quiet handling, lightweight, corrosion proof. Tapered for nesting when stored.

Overall dimensions: 12”L x 8”W x 5”D

CATALOG # 01001 17-Top



TONGS, BEAKER

Safely handle hot beakers and similar vessels, from 100 to 2000ml capacity, firmly in the grip of these tongs. Handles extend beyond the fingerholds, so that the weight of the beaker is supported by the hand instead of the fingers. Fiberglass-covered jaws, all stainless steel. 13" long (33cm).

CATALOG # 00448 77-B

**TONGS, BEAKER, PLASTISOL JAW**

Handle beakers from 50 to 1500ml capacity. Made of 1/4" diameter (6mm) nickel-plated steel wire with flat riveted joint. Plastisol coated jaws open to 4 1/2" (11cm) maximum. Overall length, 9" (23cm).

CATALOG # 00431 77-B

**TONGS, TEFLON COATED TIPS**

For handling hot, cold, corrosive, or sticky materials. Stainless-steel arms have tips covered with extra-heavy non-stick Teflon coating which means no build-up on tips or loss of sample from sticking. Does not scratch or mar delicate surfaces. Length 241mm, coating on tips extends 76mm.

CATALOG # 00271 77-B



TRIANGLES

Iron wire with ceramic tube coverings. For heating crucibles.



CATALOG #	SIDE LENGTH	
01003	2" (51MM)	76-C



TOWELS, PAPER

2-ply natural single-fold towels. Use for general cleaning and drying of hands after washing.

CATALOG #	00274	36-SIDE
-----------	-------	---------

TOWELS, KIMWIPES, DELICATE TASK WIPERS

Extra low-lint wipers suitable for polishing glassware, cleaning instruments or other delicate tasks. Soft, nonabrasive cellulose-fiber wipers won't scratch most delicate surfaces. Absorb many times their own weight. In handy dispensing packs with special plastic guard in slot to reduce airborne lint, keep contaminants out of box, and reduce electrostatic discharge. Made from 100% virgin wood fibers. White.



CATALOG #	NO. IN PACK	SIZE	
00273	280	4.4 X 8.4" (11 X 22CM)	13-B
00272	140	14.7 X 16.6" (38 X 43CM)	13-C

TOWELS, TERRI-TOWEL, WYPALL

WYPALL® X60 TERI® Reinforced Wipers, brings the absorbing power of HYDROKNIT® technology to a lighter weight wiper. Reinforced for extra scrubbing and cleaning power. Tough enough for big jobs -- soft enough for face and hands. White color.

Measures approximately 12.5 x 17 inches.



CATALOG #	00275	83-B
-----------	-------	------

TOWELS, CLEANROOM WIPERS, BERKSIRE DURX

Superior strength and absorbency make Berkshire Durx® 670 an ideal option as a general purpose wiper. Manufactured without the use of binders or surfactants, ion levels and organic extractables remain low. Durx® 670 can be used for cleaning and maintenance in laboratories as well as aerospace and defense, microelectronics, food processing, pharmaceutical, and biomedical device manufacturing environments.



CATALOG #	01278	83-C
-----------	-------	------

TUBE, CENTRIFUGE

Pyrex brand glass. Heavy duty. Round bottom. With pour-out spout for easy decanting. Non-graduated.

CATALOG #	CAPACITY (ML)	OD (MM)	LENGTH (MM)	
01007	40	29	116	87-A
01008	50	30	116	87-A

**TUBE, CENTRIFUGE, DISPOSABLE**

These disposable conical-bottom tubes feature black printed graduations and smooth inner walls for easy filling and sample preparation. A white printed writing area on the side allows for permanent coding. Rack-packed tubes are packaged in freezable, recyclable, autoclavable racks. The interlocking design of each polypropylene rack makes them ideal for benchtop organization. Tubes are sterilized by gamma irradiation. Tubes and caps are autoclavable and freezable.



CATALOG #	SIZE (ML)	PACK SIZE	
00256	15	50 per pack	16-C
00257	50	25 per pack	17-C

TUBE, CULTURE, DISPOSEABLE, WITH PLAIN END

Round bottom. Made of borosilicate glass to reduce pH changes and contaminants potentially leached from soda lime glass. Ideal for tissue culture and clinical chemistry.

CATALOG #	SIZE (mm)	
00281	13 x 100	23-Top
00277	16 x 100	23-Top
00278	18 x 150	87-D
01011	25 x 200	87-Top

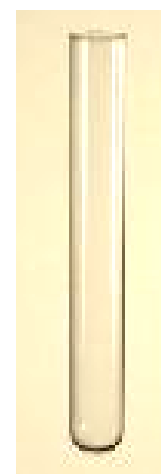

TUBE, CULTURE, SCREW CAP

Furnished with deep-form phenolic caps to facilitate handling and sealing after autoclaving. Caps are fabricated from a special formula resistant to the effects of temperature and steam in autoclaving. The white enamel marking spot gives an excellent surface for pencil notations. Pencil marks are easily erased.



CATALOG #	O.D. X LENGTH MM.	
01009	13 X 100	88-Top
01010	25 X 200	88-Top



TUBE, DRYING, POLYETHYLENE

Consists of tubular body with two serrated tips. Body has 5/8" (1.6cm) I.D. and 3/4" (1.9cm) O.D. and is 6" (15.2cm) long. Length of tip is 7/8" (2.2cm). Tips accept 1/4 to 3/8" I.D. (6.4 to 9.5cm) tubing. Easy to observe color change of indicating desiccants (not included).

CATALOG #	00289	3-U
-----------	-------	-----

TUBE, MELTING POINT, CAPILLARY

KIMAX melting point capillary tubes made from borosilicate glass. Closed at one end. 1.5 - 1.8 mm O.D. with 90MM length so that tube will extend well above the bath's surface to prevent liquid from entering the tube. Sold as 100 tubes in a vial.

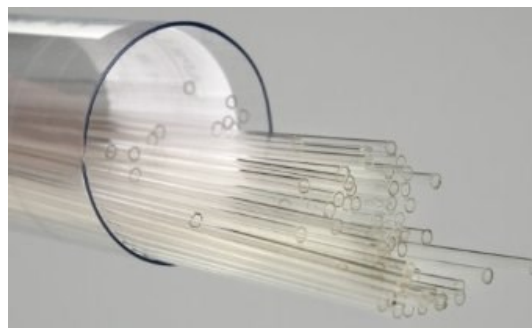

CATALOG # 00276 17-B

**TUBE, NMR**

Made of ASTM Type 1 Class B glass. Comes with cap. 300 MHz, 7" length.

5 mm — Concentricity $\pm 0.010\text{mm}$, Camber $\pm 0.038\text{mm}$

10 mm — Concentricity $\pm 0.020\text{mm}$, Camber $\pm 0.013\text{mm}$

CATALOG #	TUBE DIAMETER (MM)	
00292	5	8-A
00258	10	8-A

Replacement caps

01015— For 5 mm tube. Pressure cap. Made of ethylene vinyl acetate. Available in assorted colors.

CATALOG #	TUBE SIZE (MM)	
01015	5	8-A



TUBE, SPECTRONIC 20

Ungraduated, for Spectronic 20. Tubes are selected for uniformity and freedom from flaws in light path zone so that majority match within $\pm 1\%$ of transmittance reading, but should be matched by the user for best results. Marking spot and reference line permit realignment. Tube measures 13mm x 100mm.

CATALOG # 00293 23-Top

TUBE, TLC SPOTTING, 4"

These are non-calibrated tubes made from borosilicate glass for use with aqueous and organic solutions. 1.0-1.1 mm OD x 0.66-0.70 mm ID. Each package is approximately half a pound, and contains approximately 2000 pieces.



CATALOG # 01236 17-B

TUBE, TEST

These tubes are made from special tubing to give the optimum wall thickness. They are well annealed, resistant to heat and chemically stable. Rims are fire polished.



CATALOG #	CAPACITY (ML)	O.D. X LENGTH (MM)	
01112	9	13 X 100	23-A
01113	14	15 X 125	23-A
01114	27	18 X 150	87-B
01115	55	25 X 150	87-C
01116	70	25 X 200	87-C

TUBING, GLASS, STANDARD WALL

Made of Pyrex glass, with standard wall thickness. Low expansion borosilicate composition with high chemical resistance. Meets all U.S. pharmacopoeia specifications for Type 1A glass. Softening point 821° C. (1509°F). Working (forming) point, 1252°C (2885°F).

Available in standard 4 foot lengths.

CATALOG #	O.D. (mm)	WALL (mm)	
00296	2	0.5	GlassRack-A-1
01016	3	0.6	GlassRack-A-2
01017	4	0.8	GlassRack-A-3
01129	5	0.8	GlassRack-B-1
01018	6	1.0	GlassRack-B-2
01019	7	1.0	GlassRack-B-3
01020	8	1.0	GlassRack-C-1
00297	9	1.0	GlassRack-C-2
01021	10	1.0	GlassRack-C-2
01022	12	1.2	GlassRack-C-3
01023	15	1.2	GlassRack-D-1
01024	16	1.2	GlassRack-D-2
01025	28	1.5	GlassRack-Top,D
01026	50		GlassRack-Top
01039	75		GlassRack-Top

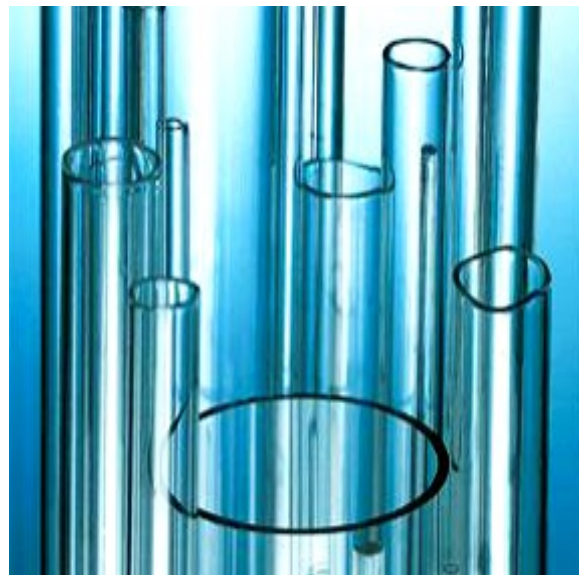

TUBING, GLASS, CAPILARY

Low expansion, borosilicate glass tubing. Softening and working temperatures same as standard wall tubing listed above. In standard 4ft lengths.



CATALOG #	O.D.	APPROX BORE	
01027	6.5MM (±0.4)	1MM (±0.2)	GlassRack-F-1
01028	7.5MM (±0.4)	1.5MM (±0.2)	GlassRack-F-2
01029	9.0MM (±0.4)	2.5MM (±0.2)	GlassRack-F-2

TUBING, GLASS ROD

Pyrex brand rod. In standard 4ft lengths.

CATALOG #	APPROX. O.D. (MM)	
01030	3	GlassRack-E-1
01031	4	GlassRack-E-2
01032	5	GlassRack-E-2

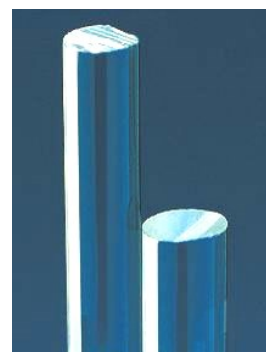

TUBING, RUBBER LATEX

Environmentally friendly—manufactured with no ozone-depleting chemicals. Tubing contains dry natural rubber. Meets Fed. Spec. A-A-53848 (MIL-T36966), MIL-R-6891, ZZ-T-831D types 1 and 3. Amber meets U.S. Pharmacopeia Class VI criteria. Talc-free: nontacky. Autoclavable. Can be EtO-sterilized. Soft, pliable, seamless. Tensile strength, 3000psi. Ultimate elongation, 850%. Durometer hardness: Shore A, 35 ± 5. Use at temperatures from -18° to + 70°C (0° to 158°F). Black tubing has nonslip surface.

CATALOG #	INNER DIAM (INCHES)	WALL (INCHES)	OUTER DIAM (INCHES)	COLOR	
01037	1/8	1/16	1/4	AMBER	30-B
00412	3/16	1/16	5/16	AMBER	30-B
01042	1/4	1/16	3/8	AMBER	30-C
01044	1/4	1/8	1/2	AMBER	30-C
00424	5/16	3/32	1/2	AMBER	30-D
01047	3/8	3/32	9/16	AMBER	30-D
01048	3/8	1/8	5/8	AMBER	30-D

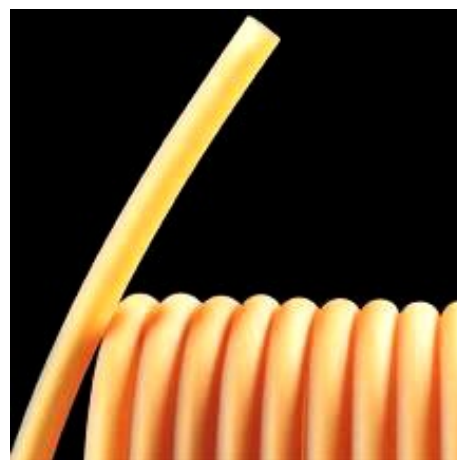

TUBING, POLYETHYLENE, NALGE 8010

Low—density polyethylene. Complies with FDA regulations for food use. Does not comply with NSF Standard 51 for Food Zone Use. Nontoxic, odorless, tasteless. Translucent, semirigid. Fluid levels easily seen. Not autoclavable; can be chemically sterilized. Superior chemical resistance. Excellent for laboratory and industrial use.

CATALOG #	INNER DIAM (INCHES)	WALL (INCHES)	OUTER DIAM (INCHES)	
01084	1/8	1/16	1/4	30-A
01085	1/4	1/16	3/8	30-A



TUBING, FLUOROPOLYMER, FEP

Fluoropolymer tubing is recommended in many demanding areas such as chromatography, semiconductor processing, Type 1 Water, and cryogenic applications. Tubing offers the ultimate in purity, chemical resistance, and broad temperature capability for handling ultra-pure fluids or highly corrosive materials. FEP tubing has the greatest clarity and abrasion resistance. Transparent to UV light. FDA compliant. Recommended operating temperature: -273°C (-459.4°F) to 204°C (400°F). Durometer hardness: Shore D, 55. Tensile strength : 2600psi.



CATALOG #	INNER DIAM.	WALL	OUTER DIAM.	
00438	1/4"	1/32"	5/16"	74-TOP

TUBING, RUBBER, PRESSURE AND VACUUM

Red or black rubber tubing with thick walls for pressure and vacuum work.



CATALOG #	INNER DIAM. (INCHES)	WALL (INCHES)	OUTER DIAM. (INCHES)	
01060	1/4	3/16	5/8	30-B
01052	5/8	3/8	1 3/8	71-TOP

TUBING, TYGON, PRESSURE

Tygon pressure tubing is reinforced with a tough polyester inner-braid imbedded in the wall, allowing it to handle four times the pressure of non-reinforced tubing. Tygon Pressure Tubing is compatible with virtually all non-solvent chemicals, meeting the needs of many industries in hundreds of applications where flexibility and higher pressure are required. Its clear wall permits positive flow monitoring and inspection. The smooth inner bore (smoother than virtually all stainless steel) will not trap bacteria-harboring particles, making it ideal for food and beverage use. It is non-toxic, odorless, taste free, and exhibits outstanding resistance to the alkaline cleaners used in this industry.

- * Handles four times the pressure of non reinforced tubing*
- * Smooth, non-porous bore won't trap particulate matter*
- * Clear wall for visualization of flow*
- * Meets FDA, 3-A, and NSF criteria*



CATALOG #	INNER DIAM. (INCHES)	WALL (INCHES)	OUTER DIAM. (INCHES)	
00458	3/8	1/8	5/8	30-Top
00459	1/2	1/8	3/4	30-Top

TUBING, TYGON, R-3603 FORMULATION

Tygon Laboratory Tubing is crystal clear and flexible and handles virtually all inorganic chemicals found in a lab. It is non-oxidizing and non-contaminating. Long lasting and crack resistant, Tygon Laboratory Tubing is less permeable than rubber tubing. The glassy-smooth inner bore helps prevent buildup so that cleaning is facilitated. Coils are marked at 1-foot intervals for easy measuring. Autoclavable. Remains flexible at -45F. Durometer hardness: Shore A, 55.

*** Outstanding chemical resistance**

*** Lot-to-lot consistency for reproducible results**

*** Increases productivity in peristaltic pumps, outlasts other clear tubing 2 to 1**

*** Ideal for condensers, incubators, desiccators, gas lines, and drain lines**

TYGON®



CATALOG #	INNER DIAM. (INCHES)	WALL (INCHES)	OUTER DIAM. (INCHES)	
01038	1/16	1/32	1/8	31-A
01065	3/32	1/32	5/32	31-A
01066	1/8	1/32	3/16	31-A
01067	1/8	1/16	1/4	31-B
01082	3/16	1/32	1/4	31-B
01079	3/16	1/16	5/16	31-C
01068	3/16	1/8	7/16	31-B
01069	1/4	1/16	3/8	31-B
01081	1/4	3/32	7/16	31-D
01071	5/16	1/16	7/16	31-C
01080	5/16	3/32	1/2	31-D
01072	3/8	1/16	1/2	31-C
01073	3/8	1/8	5/8	31-C
01074	1/2	1/16	5/8	31-C
01075	1/2	3/32	11/16	31-E
01083	5/8	3/32	13/16	31-E
01077	3/4	1/8	1	31-Top
01078	1	1/8	1 1/4	31-E

VIALS, POLYETHYLENE CLOSURES

Opticlear, general purpose vials. Made from Type 1, N-51A borosilicate glass. Tolerated necks ensure accurate fit with closures. The 1-dram size comes with open-bottom closures; all other sizes come with closed-bottom closures. Closures are packed separately.

CATALOG #	CAPACITY	O.D. X H. (MM)	
01088	1 Dram (3.69 mL)	15 X 45	74-C
01089	2 Dram (7.39 mL)	19 X 48	74-C
01090	3 Dram (11.09 mL)	21 X 50	74-D
01091	4 Dram (14.78 mL)	25 X 52	74-D
01092	5 Dram (18.48 mL)	27 X 55	75-D



VIALS, SCREW CAP

General-purpose vials. Made from Type 1, Class B borosilicate glass. Black phenolic screw-top closures have polyvinyl-faced pulp liners.



CATALOG #	CAPACITY	O.D. X H. (MM)	
01093	1 Dram (3.69 mL)	15 X 45	17-A
01094	2 Dram (7.39 mL)	17 X 60	18-A
01095	3 Dram (11.09 mL)	19 X 65	18-A
01096	4 Dram (14.78 mL)	28 X 57	18-B
01097	6 Dram (22.18 mL)	23 X 85	18-B
01141	8 Dram (29.57 mL)	25 X 95	18-C
01098	11 Dram (40.66 mL)	28 X 108	18-C

VIALS, SNAP CAP, STYRENE

These strong clear vials are made of polystyrene and come with tight fitting caps, which protect against moisture, dust, and dirt. They are ideal for storing and packaging a wide variety of small parts, samples, and bulk material. Meet FDA standards.

CATALOG #	CAPACITY	O.D. X H. (In.)	
01301	3 Dram (11.09 mL)	3/4" x 1 7/8"	75-A
01302	5 Dram (18.48 mL)	7/8" x 2"	75-A
01303	7 Dram (25.87 mL)	1 1/16" x 2"	75-B
01304	10 Dram	1 1/16" x 3 1/4"	75-C
01306	30 Dram	1 13/16" x 3"	75-D



VIALS, AUTOSAMPLER, 1.5 mL

These clear glass vials screw-top vials are the standard design for autosamplers. They are manufactured from Type 1, borosilicate glass and measure 12 x 32mm. Vials have GPI thread finish of 8-425 and 1.5 mL volume. Open-top phenolic caps permit access to contents with a syringe. Vials are unassembled and come with phenolic caps and white PTFE-faced red rubber septa.



CATALOG #	00435	13-A
------------------	-------	------

WATCH GLASS, FIRE POLISHED

Concave shape prevents sliding. Returns condensation to beaker. Great for covering boiling solution for 30 to 4000 mL low-form beakers. Also for funnels, dishes, jars. Fire polished edges for strength.



CATALOG #	DIAMETER	
01100	2.5" (65 MM)	77-A
01101	3" (75 MM)	77-A
01102	3.5" (90 MM)	77-A
01103	4" (100 MM)	77-A
01105	6" (150 MM)	77-A
01106	7" (175 MM)	77-A

WEIGHING PAPER, LOW NITROGEN

For analytical balances. Sufficient body to support sample. Smooth textured to avoid trapping material. Does not absorb moisture.

Comes in boxes containing 500 sheets.

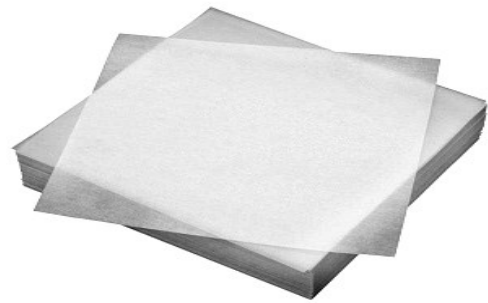

CATALOG #	00309	3-S
------------------	-------	-----

WIRE GAUZE SQUARE, STAINLESS STEEL

Stainless steel mesh for long life and safety. For use up to 800° C (4712° F). Square measures 5" x 5" (12.7 x 12.7 cm).

Item # 00313 contains ceramic fiber center to provide protection against flame. Mesh edges are turned to prevent fraying.



CATALOG #	00312	90-C
	00313	90-C

WIPE, HYGIENIC, PRE-MOISTENED

This Pyramex brand cleaning wipe removes body oils and perspiration from respirators and PPE. For use on respirators, personal equipment, self-contained breathing apparatus, hard hat suspensions, and more.

Wipes are alcohol-free and individually wrapped. Sold in boxes of 100 wipes.

CATALOG #	01400	2-A
------------------	-------	-----



FITTINGS & VALVES

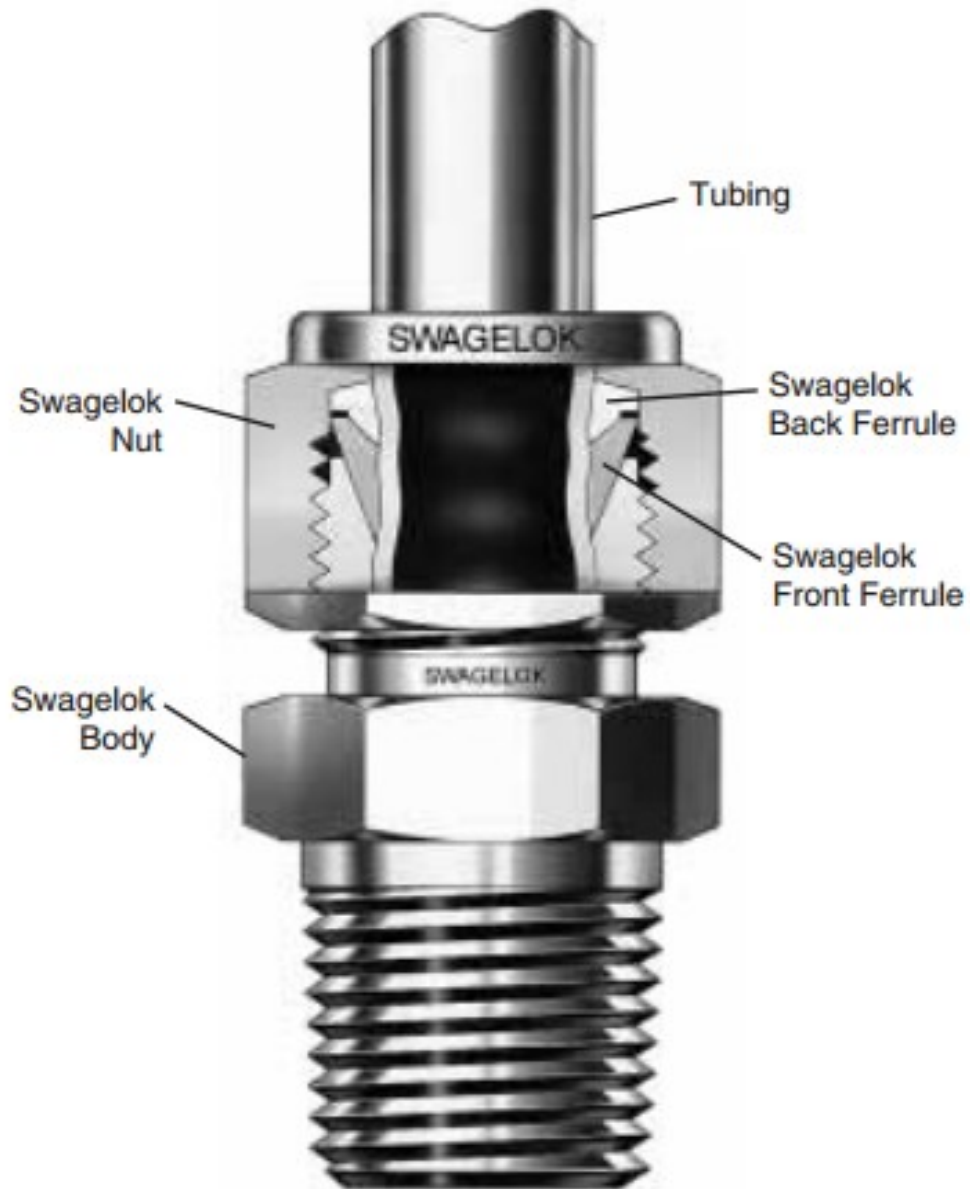

Male Connector - Fractional Tube to Male NPT Thread



<u>Material</u>	<u>Tube O.D. (in)</u>	<u>Pipe Size (in)</u>	<u>Catalog #</u>	
Stainless Steel	1/16	1/8	30001	Y-7
Stainless Steel	1/8	1/8	30003	Y-8
Brass	1/8	1/8	30004	Y-8
Stainless Steel	1/8	1/4	30006	Y-8
Brass	1/8	1/4	30007	Y-8
Stainless Steel	1/4	1/16	30008	Y-8
Stainless Steel	1/4	1/8	30010	Y-8
Brass	1/4	1/8	30011	Y-8
Stainless Steel	1/4	1/4	30013	Y-8
Nylon	1/4	1/4	30015	Y-9
Stainless Steel	1/4	3/8	30016	Y-9
Brass	1/4	3/8	30017	Y-9
Nylon	1/4	3/8	30018	Y-9
Brass	3/8	3/8	30106	Y-9
Stainless Steel	3/8	3/8	30107	Y-9
Brass	3/8	1/4	30126	Y-9
Stainless Steel	3/8	1/4	30124	Y-9
Stainless Steel	1/2	1/4	30147	Y-10
Stainless Steel	1/2	1/2	30146	Y-10

Female Connector - Fractional Tube to Female NPT Thread

<u>Material</u>	<u>Tube O.D. (in)</u>	<u>Pipe Size (in)</u>	<u>Catalog #</u>	
Stainless Steel	1/8	1/4	30019	Y-10
Brass	1/8	1/4	30020	Y-10
Stainless Steel	1/4	1/4	30021	Y-10
Brass	1/4	1/4	30022	Y-10
Nylon	1/4	1/4	30023	Y-10
Brass	1/4	1/8	30104	Y-10
Stainless Steel	1/4	1/8	30144	Y-11
Stainless Steel	3/8	3/8	30109	Y-11

Male Elbow - 90° Fractional Tube to Male NPT Thread

<u>Material</u>	<u>Tube O.D. (in)</u>	<u>Pipe Size (in)</u>	<u>Catalog #</u>	
Stainless Steel	1/4	1/8	30031	Y-11
Stainless Steel	1/4	1/4	30034	Y-11

Union - Fractional Tube to Fractional Tube



<u>Material</u>	<u>Tube O.D. (in)</u>	<u>Catalog #</u>	
Stainless Steel	1/16	30040	Y-4
Brass	1/8	30043	Y-4
Nylon	1/8	30044	Y-5
Brass	1/4	30046	Y-5
Stainless Steel	3/8	30111	Y-5
Brass	3/8	30110	Y-5
Stainless Steel	1/2	30152	Y-5

Reducing Union - Fractional Tube to Fractional Tube



<u>Material</u>	<u>Tube O.D. (in)</u>	<u>Reducing to Tube O.D. (in)</u>	<u>Catalog #</u>	
Brass	1/8	1/16	30049	Y-7
Stainless Steel	1/4	1/8	30052	Y-7
Brass	1/4	1/8	30053	Y-7
Nylon	1/4	1/8	30054	Y-7
Stainless Steel	3/8	1/4	30113	Y-7
Stainless Steel	1/2	1/4	30150	Y-7

Union Elbow 90° - Fractional Tube to Fractional Tube

<u>Material</u>	<u>Tube O.D. (in)</u>	<u>Catalog #</u>	
Brass	1/4	30059	Y-5
Stainless Steel	1/4	30058	Y-5
Stainless Steel	1/2	30153	Y-5

Union Tee - All Connections Same Fractional Tube

<u>Material</u>	<u>Tube O.D. (in)</u>	<u>Catalog #</u>	
Stainless Steel	1/16	30061	Y-6
Brass	1/16	30062	Y-6
Stainless Steel	1/8	30063	Y-6
Stainless Steel	1/4	30066	Y-6
Brass	1/4	30067	Y-6
Nylon	1/4	30068	Y-6
Brass	3/8	30114	Y-6
Stainless Steel	1/2	30156	Y-6

Cap - For Capping end of Fractional Tube



<u>Material</u>	<u>Tube O.D. (in)</u>	<u>Catalog #</u>	
Stainless Steel	1/4	30074	Y-2
Brass	1/4	30075	Y-2
Stainless Steel	3/8	30116	Y-2
Stainless Steel	1/2	30155	Y-3

Plug - For Plugging Unused Port of Fractional Tube



<u>Material</u>	<u>Tube O.D. (in)</u>	<u>Catalog #</u>	
Stainless Steel	1/16	30077	Y-3
Brass	1/8	30080	Y-3
Stainless Steel	1/4	30082	Y-3
Brass	1/4	30083	Y-3
Stainless Steel	3/8	30118	Y-3
Stainless Steel	1/2	30154	Y-3

Nut - Fractional Tube

<u>Material</u>	<u>Tube O.D. (in)</u>	<u>Catalog #</u>	
Stainless Steel	1/16	30085	Y-3
Stainless Steel	1/8	30087	Y-4
Stainless Steel	1/4	30090	Y-4
Brass	1/4	30091	Y-4
Nylon	1/4	30092	Y-4
Brass	3/8	30119	Y-4
Stainless Steel	1/2	30157	Y-4

Ferrules - Back and Front sets for Fractional Tube

<u>Material</u>	<u>Tube O.D. (in)</u>	<u>Catalog #</u>	
Stainless Steel	1/16	30093	Y-1
Stainless Steel	1/8	30094	Y-1
Brass	1/8	30095	Y-1
Nylon	1/8	30096	Y-1
Stainless Steel	1/4	30097	Y-1
Brass	1/4	30098	Y-1
Nylon	1/4	30099	Y-1
Stainless Steel	3/8	30122	Y-2
Brass	3/8	30121	Y-1
Stainless Steel	1/2	30145	Y-2

Inserts - For Vinyl or Tygon Tubing.

Swagelok inserts are used in securing soft plastic tubing with standard Swagelok tube fittings.



<u>Material</u>	<u>Tube O.D. (in)</u>	<u>Tube I.D. (in)</u>	<u>Catalog #</u>	
Stainless Steel	1/4	1/8	30134	Y-2
Brass	3/8	1/4	30141	Y-2
Stainless Steel	3/8	1/4	30142	Y-2

Union Tee - Fractional Tube to Male Branch Tee.

Both tube ports are identical. Tapered thread.



<u>Material</u>	<u>Tube O.D. (in)</u>	<u>NPT SIZE (in)</u>	<u>Catalog #</u>	
Brass	3/16	1/8	30105	Y-B10-8



Hose Barb - Male

Catalog #	Tube I.D.	NPT Size	
30172	1/4"	1/4"	R-7
30173	1/4"	3/8"	R-7
30174	1/4"	1/2"	R-7
30175	3/8"	3/8"	R-7



Hose Barb - Female

Catalog #	Tube I.D.	NPT Size	
30169	1/4"	1/4"	R-7
30170	3/8"	3/8"	R-7



NPT Male Branch tee

Catalog #	NPT	Barb size	
30311	1/8"	1/4"	R-7

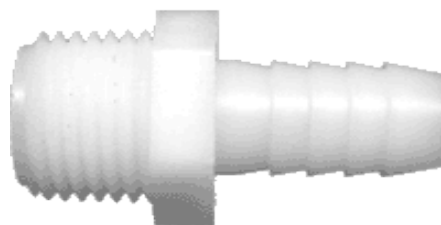

NPT Male Pipe Adapter Connector

Catalog #	NPT	Barb size	
30323	1/8" NPT	1/4" I.D.	R-7
30329	1/4" NPT	1/4" I.D.	R-8
30331	1/4" NPT	3/8" I.D.	R-8
30334	3/8" NPT	5/16" I.D.	R-8
30338	1/2" NPT	3/8" I.D.	R-8
30339	1/2" NPT	1/2" I.D.	R-8

PVDE, Nylon, & Polypropylene Tubing Fittings

Superior single-barb design provides a leak-proof seal. These fittings are ideal for use with flexible tubing. **Black Nylon** offers good tensile strength for general applications. Temp. range: 40 to 200 °F. **Natural Polypropylene** offers good chemical resistance. Temp. range: 32 to 212 °F. **Natural PVDE** (Polyvinylidene Fluoride) offers the ultimate chemical and abrasive resistance and strength. Temp. range: -80 to 275 °F.

NPT Coupler, Reducing/Enlarging



Catalog #	Tube I.D.	Tube I.D.	
30361	1/16"	1/8"	R-5
30366	3/16"	1/16"	R-5
30367	3/16"	3/32"	R-5
30368	3/16"	1/8"	R-5
30370	1/4"	1/8"	R-5
30372	1/4"	3/16"	R-5
30373	5/16"	1/4"	R-6
30374	3/8"	1/4"	R-6
30375	3/8"	5/16"	R-6
30376	1/2"	1/4"	R-6
30377	1/2"	5/16"	R-6
30378	1/2"	3/8"	R-6
30384	3/4"	1/2"	R-6
30386	1"	1/2"	R-6

NPT Coupler

Catalog #	Tube I.D.	
30352	5/32"	R-4
30354	1/4"	R-4
30356	3/8"	R-5



This page intentionally left blank.

P4T & P6T SERIES PLUG VALVES

Fast-acting, 1/4-turn shutoff

PURPOSE

NUPRO Plug Valves offer reliable shutoff, high flow capacity, and fast operation in a simple, compact design. A quarter turn of the handle provides fully open to fully closed actuation. Intermediate positions allow forward flow throttling. NUPRO Plug Valves operate over wide pressure and temperature ranges.

DESIGN

The design consists of three major components: body, plug assembly, and handle. The plug and three O-ring seals are TFE coated to provide lubrication between the plug assembly and the body bore. The valve features very low torque operation, even at the maximum pressure rating. System pressure acts on equal body seal areas to prevent unbalanced plug load, which promotes safety. As the valve is actuated, a bleed groove in the plug vents any trapped, pressurized fluids from the plug orifice to the downstream port.

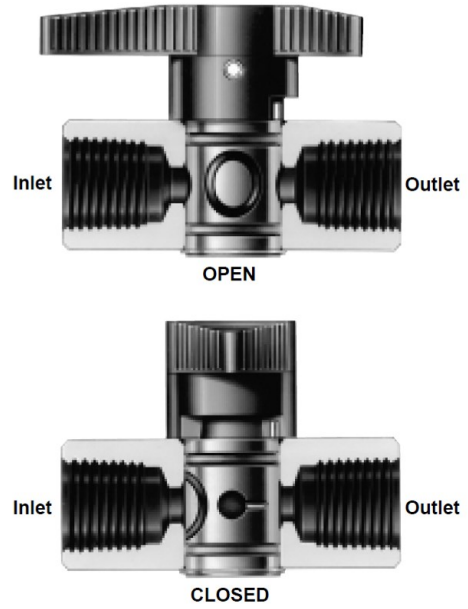

Operation

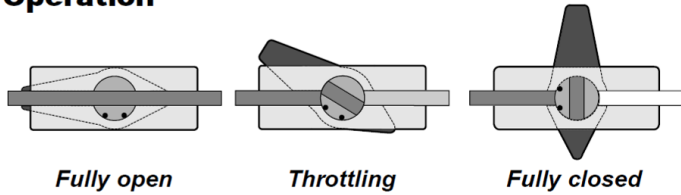

UCS CATALOG #	Vendor CATALOG #	
30166	SS-6P4T	Y-11
30167	B-4JN2	Y-11
30445	B-4JN4	Y-11

FEATURES

- Positive shutoff — every valve is factory-tested
- Every valve is factory tested for shutoff at 600 psig (41 bar).
- Strait-through flow — minimal pressure drop
- Low-torque actuation
- Quarter-turn, fast acting operation
- Throttling capability (forward flow direction only)
- Simple design for high reliability
- Compact size — attractive appearance
- O-ring seal to atmosphere — no packings to adjust
- One-piece body construction for safety
- Color-coded, flow-directional handles
- Long life cycle
- Moderate vacuum service

TABLE OF DIMENSIONS

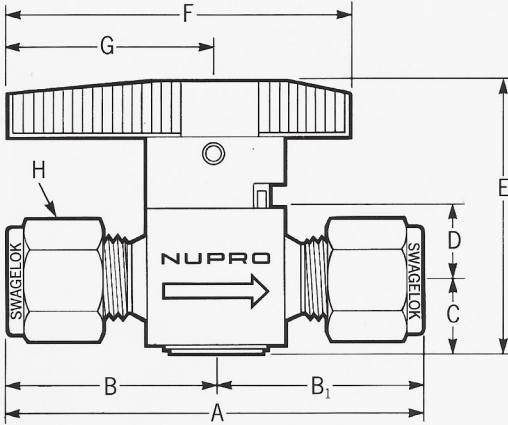
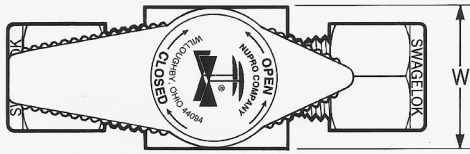

TECHNICAL DATA

Valve Series	Standard Material	Pressure Rating ^② at 70°F (21°C)	Temperature Rating
P4T	Brass & 316SS	3000 psig (206 bar)	-10° to 400°F (-23° to 204°C) with TFE coated Viton seals
P6T	Brass	2000 psig (137 bar)	
	316SS	3000 psig (206 bar)	

② If reverse flow occurs, differential pressure is limited to 150 psi (10 bar) max. In such cases, the valve should be actuated quickly to prevent O-Ring damage.

FLOW CAPACITY DATA

Basic Ordering Number	C _v	Pressure Drop To Atmosphere (Δp) psi					
		Air std ft ³ /min. at 70°F (21°C)			Water U.S. gal/min. at 70°F (21°C)		
		10	50	100	10	50	100
-2P4T	0.2	2.26	6.00	10.64	0.63	1.41	2.00
-2P4T2	1.0	11.30	30.01	53.20	3.16	7.07	10.00
-2P4T4	1.0	11.30	30.01	53.20	3.16	7.07	10.00
-4P4T	1.4	15.82	42.01	74.48	4.43	9.90	14.00
-4P4T1	1.4	15.82	42.01	74.48	4.43	9.90	14.00
-4P4T2	0.9	10.17	27.01	47.88	2.85	6.36	9.00
-4P4T4	0.9	10.17	27.01	47.88	2.85	6.36	9.00
-4P4T4-RT	0.9	10.17	27.01	47.88	2.85	6.36	9.00
-4P4T5	0.9	10.17	27.01	47.88	2.85	6.36	9.00
-6P4T	1.1	12.43	33.01	58.52	3.48	7.78	11.00
-6P4T-MM	1.4	25.99	69.02	122.36	7.27	16.26	23.00
-4P6T4	3.6	40.68	108.03	191.51	11.38	25.46	36.00
-6P6T	7.0	79.09	210.06	372.39	22.14	49.50	70.00
-8P6T	4.0	45.20	120.03	212.79	12.65	28.28	40.00
-8P6T2	2.3	25.99	69.02	122.36	7.27	16.26	23.00
-8P6T4	2.3	25.99	69.02	122.36	7.27	16.26	23.00
-8P6T4-RT	2.3	25.99	69.02	122.36	7.27	16.26	23.00
-10P6T-MM	5.7	64.40	171.05	303.23	18.02	40.31	57.00
-12P6T-MM	4.3	48.59	129.03	228.75	13.60	30.41	43.00

Plug Valves			End Connections		Dimensions ^④									
Basic ^③ Ordering Number	Plug Orifice		Inlet	Outlet	A	B	B ₁	C	D	E	F	G	H Hex	W
	in.	mm												
-2P4T ^⑤	0.172	4.4	1/8 SWAGelok		1.99	0.99	0.99	0.45	0.37	1.52	1.88	1.14	7/16	0.75
-2P4T2			1/8 Male NPT		1.53	0.76	0.76						-	
-2P4T4			1/8 Female NPT		1.78	0.89	0.89						-	
-4P4T			1/4 SWAGelok		2.17	1.08	1.08						9/16	
-4P4T1			1/4 Male NPT		2.03	0.95	1.08						9/16	
-4P4T2			1/4 Male NPT		1.90	0.95	0.95						-	
-4P4T4			1/4 Female NPT		2.09	1.05	1.05						-	
-4P4T4-RT			1/4 Female ISO/BSP Tapered ^⑥		2.21	1.11	1.11						-	
-4P4T5			1/4 Male NPT		2.00	0.95	1.05						-	
-4P4T5			1/4 Female NPT		2.00	0.95	1.05						-	
-6P4T	0.281	7.2	3/8 SWAGelok		2.29	1.14	1.14	0.66	0.56	2.13	2.49	1.50	11/16	1.12
-6P4T-MM			6mm SWAGelok		2.17	1.08	1.08						14mm	
-4P6T4			1/4 Female NPT		2.38	1.19	1.19						-	
-6P6T			3/8 SWAGelok		2.66	1.33	1.33						11/16	
-8P6T			1/2 SWAGelok		2.88	1.44	1.44						7/8	
-8P6T2			1/2 Male NPT		2.64	1.32	1.32						-	
-8P6T4			1/2 Female NPT		2.88	1.44	1.44						-	
-8P6T4-RT			1/2 Female ISO/BSP Tapered ^⑥		3.14	1.57	1.57						-	
-10P6T-MM			10mm SWAGelok		2.68	1.34	1.34						19mm	
-12P6T-MM			12mm SWAGelok		2.96	1.48	1.48						22mm	

③ For a complete Ordering Number, use **B** for brass, **SS** for 316 stainless steel, or **S** for carbon steel as a prefix to the Basic Ordering Number. Examples: **B**-4P4T2; **SS**-4P4T; **S**-8P6T4

④ Dimensions shown with SWAGelok nuts finger-tight, where applicable. All dimensions are in inches (except where mm is indicated) – for reference only, subject to change.

⑤ Body orifice 0.093" (2.4mm).

⑥ Reference Specifications: BS21 & ISO 7/1

This page intentionally left blank.

CHEMICALS

Acetic Acid, Glacial	Size	Catalog #
CH₃COOH 64-19-7	500 mL	20003
Location 40-A, B	2 1/2 L	20004
Acetic Anhydride, ACS	Size	Catalog #
(CH₃CO)₂O 108-24-7	500 mL	20006
Location 42-A		
Acetone, ACS	Size	Catalog #
CH₃COCH₃ 67-64-1	500 mL	20008
Location 52-A, B, C	4 L	20011
Acetone-d₆, 99.5%	Size	Catalog #
CD₃COCD₃ 666-52-4	10 g	20007
Location 52-B		
Acetonitrile, ACS	Size	Catalog #
CH₃CN 75-05-8	4 L	20013
Location 67-B		
Acetonitrile, HPLC	Size	Catalog #
CH₃CN 75-05-8	1 L	20012
Location 67-A		
Acetophenone, AR	Size	Catalog #
C₆H₅COCH₃ 98-86-2	500 mL	20018
Location 65-A		
Adipic Acid, Certified	Size	Catalog #
HO₂C(CH₂)₄CO₂H 124-04-9	500 g	20023
Location 56-A		
Aluminum Chloride, Anhydrous	Size	Catalog #
AlCl₃ 7446-70-0	500 g	20033
Location 42-B		
Aluminum Oxide, Anhydrous	Size	Catalog #
Al₂O₃ 1344-28-1	500 g	20035
Location 64-B		

Aluminum Potassium Sulfate, ACS AlK(SO₄)₂ · 12H₂O 7784-24-9 Location 6-B	Size 500 g	Catalog # 20036
Aluminum Sulfate, Octadecahydrate, GR Al₂(SO₄)₂ · 18H₂O 17927-65-0 Location 6-B	Size 500 g	Catalog # 20038
Ammonium Chloride, ACS (NH₄)Cl 12125-02-9 Location 6-B	Size 500 g	Catalog # 20048
Ammonium Hydroxide, ACS, 28-30% NH₄OH 1336-21-6 Location 41-A, B	Size 500 mL 2.5 L	Catalog # 20051 20052
Ammonium Persulfate, Crystal (NH₄)₂S₂O₈ 7727-54-0 Location 6-B	Size 500 g	Catalog # 20057
Ammonium Thiosulfate, 99% (NH₄)₂S₂O₃ 7783-18-8 Location 6-C	Size 500 g	Catalog # 20062
n-Amyl Alcohol CH₃(CH₂)₄OH 71-41-0 Location 57-A	Size 500 mL	Catalog # 20065
iso-Amyl Alcohol (CH₃)₂CHCH₂CH₂OH 123-51-3 Location 57-A	Size 500 mL	Catalog # 20064

Anisole, 99% C₆H₅OCH₃ 100-66-3 Location 67-A	Size 100 mL	Catalog # 20071	
Ascarite II, 8 - 20 Mesh, CO₂ Absorbent 81133-20-2 Location 64-A	Size 500 g	Catalog # 20334	
Barium Acetate Ba(C₂H₃O₂)₂ 543-80-6 Location 6-C	Size 500 g	Catalog # 20080	
Barium Chloride, Dihydrate, ACS BaCl₂ 2 H₂O 10326-27-9 Location 6-B	Size 500 g	Catalog # 20082	
Benzene, ACS C₆H₆ 71-43-2 Location 59-A	Size 500 mL 4 L	Catalog # 20089 20090	
Boileezers, Granules for Distillations Al₂O₃ 1344-28-1 Location 64-B	Size 250 g	Catalog # 20669	
Buffer Solution Location 5-A Liquid Health Hazard	pH (Color) 4.00 (Red) 7.00 (Yellow) 10.00 (Blue)	Size 500 mL 500 mL 500 mL	Catalog # 20123 20125 20126
n-Butanol, ACS CH₃(CH₂)₃OH 71-36-3 Location 57-B	Size 500 mL	Catalog # 20127	

Carbon, Decolorizing, Norit*		
C 7440-44-0	Size	Catalog #
Location 64-A	500 g	20176
Carbon Disulfide, Certified ACS		
CS₂ 75-15-0	Size	Catalog #
Location 67-C	500 mL	20168
Chloroform, Certified ACS		
CHCl₃ 67-66-3	Size	Catalog #
Location 61-A, B	500 mL	20183
	4 L	20185
Chloroform-d, 99.9 atom% D		
CDCl₃ 865-49-6	Size	Catalog #
Location 61-A	100 mL	20187
Chloroform-d, 99.9 atom% D, 1% TMS		
CDCl₃	Size	Catalog #
Location 61-A	100 mL	20186
Citric Acid, Monohydrate, ACS		
HOC(CO₂H)(CH₂CO₂H)₂ H₂O 5949-29-1	Size	Catalog #
Location 56-B	500 g	20199
Copper, Shot, Certified ACS		
Cu 7440-50-8	Size	Catalog #
Location 66-A	500 g	20203
m-Cresol, 97%		
CH₃C₆H₄OH 108-39-4	Size	Catalog #
Location 13-A	500 g	20205
Cupric Acetate, Monohydrate, ACS		
(CH₃CO₂)₂Cu H₂O 6046-93-1	Size	Catalog #
Location 6-C	500 g	20207

Cupric Oxide, Powder, ACS**CuO 1317-38-0**

Location 64-B

Size

500 g

Catalog #

20210

Cupric Sulfate, Pentahydrate, ACS**CuSO₄ 5 H₂O 7758-99-8**

Location 7-B

Size

500 g

Catalog #

20211

Cyclohexene, Reagent (contains .01% tert-Butylcresol)**C₆H₁₀ 110-83-8**

Location 59-A

Size

1 L

Catalog #

20050

Deuterium Oxide, 99.9 atom % D**D₂O 7789-20-0**

Location 4-C

Size

25 g

Catalog #

20265

Dextrose, Anhydrous, Certified ACS**C₆H₁₂O₆ 50-99-7**

Location 56-C

Size

500 g

Catalog #

20227

Dichloromethane, stabilized, certified ACS**CH₂Cl₂ 75-09-2**

Location 47-A,B,C

Size

500 mL

Catalog #

20243

4 L

20244

Dimethylglyoxime, Certified ACS**CH₃C:NOHC:NOHCH₃ 95-45-4**

Location 56-C

Size

100 g

Catalog #

20259

Dimethyl Sulfoxide	Size	Catalog #
(CH₃)₂SO (DMSO) 67-68-5	500 mL	20264
Location 58-A, B	4 L	20263
<hr/>		
Dimethyl Sulfoxide-d₆, 99.9 atom% D	Size	Catalog #
(CD₃)₂SO (DMSO) 2206-27-1	10 g	20260
Location 15-A		
<hr/>		
Dimethyl Sulfoxide-d₆, 99.9 atom% D, 1% TMS	Size	Catalog #
(CD₃)₂SO (DMSO) 2206-27-1	10 g	20262
Location 15-A		
<hr/>		
N,N-Dimethylformamide, ACS, >=99.8%	Size	Catalog #
HCON(CH₃)₂ 68-12-2	4 L	20257
Location 57-B		
<hr/>		
Drierite dessicant, 8 Mesh, White, Non-Indicating	Size	Catalog #
CaSO₄ 7778-18-9	1 lb	20340
Location 6-D		
<hr/>		
Drierite dessicant, 8 Mesh, Blue, Indicating	Size	Catalog #
CaSO₄ 7778-18-9	1 lb	20341
Location 6-D		
<hr/>		
Dry Ice (Solid carbon dioxide)	Size	Catalog #
CO₂	1 lb	20901
Location (Cryo Room)		
<hr/>		

Ethyl Acetate, HPLC	Size	Catalog #
CH₃COOC₂H₅ 141-78-6	500 mL	20285
Location 48-A, B, C	1 L	20283
	4 L	20284
<hr/>		
Ethyl Alcohol (ethanol), 190 Proof, USP	Size	Catalog #
C₂H₅OH 64-17-5	1 gal	20286
Location 51-A,CB, C	5 gal	20287
<hr/>		
Ethyl Alcohol (ethanol), 200 Proof, USP	Size	Catalog #
C₂H₅OH 64-17-5	1 gal	20289
Location 50-A, B, C	5 gal	20288
<hr/>		
Ethylene Glycol, Certified	Size	Catalog #
HOCH₂CH₂OH 107-21-1	1 L	20294
Location 65-B	4 L	20295
<hr/>		
Ethyl Ether, Anhydrous, Certified ACS	Size	Catalog #
C₂H₅OC₂H₅ 60-29-7	1 L	20733
Location 55-A		
<hr/>		
Ferric Ammonium Sulfate, Dodecahydrate	Size	Catalog #
FeNH₄(SO₄)₂ 12 H₂O 7783-83-7	500 g	20300
Location 7-B		
<hr/>		
Ferric Nitrate Nonahydrate, Certified ACS	Size	Catalog #
Fe(NO₃)₃ 9 H₂O 7782-61-8	100 g	20299
Location 43-A		
<hr/>		
Formaldehyde, 37%	Size	Catalog #
HCHO 50-00-0	1 L	20311
Location 59-C	4 L	20312

Glycerol, Certified ACS (Glycerin)**HOCH₂CH(OH)CH₂OH 56-81-5**

Location 65-A

Size
500 mL**Catalog #**
20323**Hexanes, Certified ACS****C₆H₁₄ 110-54-3**

Location 46-A, B

Size
4 L**Catalog #**
20353**Hexane, mixture of isomers, ACS****C₆H₁₄ 110-54-3**

Location 46-B

Size
500 mL**Catalog #**
20352**Hydrochloric Acid, 37%, Certified ACS plus****HCl 7647-01-1**

Location 39-A, B

Size
500 mL
2.5 L**Catalog #**
20361
20360**Hydrogen Peroxide, 30%, ACS****H₂O₂ 7722-84-1**

Location 44-B

Size
500 mL**Catalog #**
20364

Liquid Nitrogen		
N₂	Size	Catalog #
Cryo room	L	20900
<hr/>		
Magnesium, Metal, Ribbon 0.006"		
Mg 7439-95-4	Size	Catalog #
Location 66-A	1 oz	20738
<hr/>		
Magnesium Chloride, Hexahydrate, ACS		
MgCl₂ 6 H₂O 7791-18-6	Size	Catalog #
Location 7-C	500 g	20390
<hr/>		
Magnesium Nitrate, Hexahydrate, ACS		
Mg(NO₃)₂ 6 H₂O 13446-18-9	Size	Catalog #
Location 43-B	500 g	20393
<hr/>		
Magnesium Perchlorate, Anhydrous, Certified		
Mg(ClO₄)₂ 10034-81-8	Size	Catalog #
Location 44-A	500 g	20395
<hr/>		
Magnesium Sulfate, Heptahydrate, ACS		
MgSO₄ 7 H₂O 10034-99-8	Size	Catalog #
Location 7-C	500 g	20396
<hr/>		
Magnesium Sulfate, Anhydrous		
MgSO₄ 7487-88-9	Size	Catalog #
Location 7-C	500 g	20397
<hr/>		
Maleic Acid, AR		
HO₂CCH:CHCO₂H 110-16-7	Size	Catalog #
Location 56-A	500 g	20820
<hr/>		
Marble, Chips		
	Size	Catalog #
Location 64-A	500 g	20758

Mesityl Oxide, 98% (CH₃)₂C=CHCOCH₃ 141-79-7 Location 67-A	Size 100 g	Catalog # 20770
Methanol, Certified ACS CH₃OH 67-56-1 Location 49-A, C	Size 500 mL 4 L	Catalog # 20425 20426
Methanol, HPLC Grade CH₃OH 67-56-1 Location 49-A, B	Size 1 L 4 L	Catalog # 20424 20423
Methylene Chloride, Stabilized, Certified ACS CH₂Cl₂ 75-09-2 Location 47-A, B, C	Size 500 mL 1 L 4 L	Catalog # 20243 20225 20244
Naphthalene, Certified C₁₀H₈ 91-20-3 Location 58-A	Size 500 g	Catalog # 20456
Nitric Acid, Certified ACS plus HNO₃ 7697-37-2 Location 37-A,B	Size 500 mL 2.5 L	Catalog # 20467 20468

Oil, Mechanical Pump, Fisher Brand**64742-65-0**

Location 7-D

Size

4 L

Catalog #

20484

Oil, Pump, Flushing**64741-88-4**

Location 7-D

Size

1 qt

Catalog #

20481

Petroleum Ether, ACS**Ligroine Boiling Range 35-60 Degrees C 8032-32-4**

Location 67-C

Size

4 L

Catalog #

20492

o-Phosphoric Acid, 85%, Certified ACS**H₃PO₄ 7664-38-2**

Location 42-A

Size

500 mL

Catalog #

20514

Potash, Sulfurated**39365-88-3**

Location 4-D

Size

500 g

Catalog #

20519

Potassium Bisulfate, Certified**KHSO₄ 7646-93-7**

Location 7-C

Size

500 g

Catalog #

20524

Potassium Bromide, Certified ACS

	Size	Catalog #
KBr 7758-02-3	500 g	20525
Location 8-B		

Potassium Bromide, 99+%, FT-IR Grade

	Size	Catalog #
KBr 7758-02-3	25 g	20739
Location 8-A		

Potassium Carbonate, Anhydrous, ACS

	Size	Catalog #
K₂CO₃ 584-08-7	500 g	20526
Location 5-B		

Potassium Chloride, Certified ACS

	Size	Catalog #
KCl 7447-40-7	500 g	20529
Location 8-B		

Potassium Chromate, Certified ACS

	Size	Catalog #
K₂CrO₄ 7789-00-6	500 g	20531
Location 45-A		

Potassium Hydroxide, Pellets, ACS

	Size	Catalog #
KOH 1310-58-3	500 g	20543
Location 5-B	2.5 kg	20542

Potassium Iodate, Powder, Certified ACS

	Size	Catalog #
KIO₃ 7758-05-6	500 g	20544
Location 44-B		

Potassium Nitrate, Crystals, Certified ACS

	Size	Catalog #
KNO₃ 7757-79-1	500 g	20549
Location 48-B	2.5 kg	20548

Potassium Nitrite, Crystals, Certified ACS

	Size	Catalog #
KNO₂ 7758-09-0	500 g	20554
Location 43-B		

Potassium meta-Periodate, ACS

	Size	Catalog #
KIO₄ 7790-21-8 Location 44-B	100 g	20547

Potassium Persulfate, Crystals, Certified

	Size	Catalog #
K₂S₄O₈ 7727-21-1 Location 44-B	500 g	20551

Potassium Phosphate, Monobasic, ACS

	Size	Catalog #
KH₂PO₄ 7778-77-0 Location 8-C	500 g	20553

Potassium Sodium Tartrate, Tetrahydrate

	Size	Catalog #
NaKC₄H₄O₆ 4 H₂O 6381-59-5 Location 4-D	500 g	20556

Potassium Thiocyanate, Certified ACS

	Size	Catalog #
KSCN 333-20-0 Location 8-D	500 g	20559

n-Propanol, Certified

	Size	Catalog #
CH₃CH₂CH₂OH 71-23-8 Location 57-C	1 L	20565

iso-Propanol, Certified ACS

	Size	Catalog #
(CH₃)₂CHOH 67-63-0 Location 60-A, B	500 mL	20566
	4 L	20567

iso-Propanol, HPLC Grade

	Size	Catalog #
(CH₃)₂CHOH 67-63-0 Location 60-C	4 L	20568

Sand, Sea, washed		
14808-60-7	Size	Catalog #
Location 5-A	500 g	20577

Sodium Acetate, Anhydrous, ACS		
CH₃CO₂Na 127-09-3	Size	Catalog #
Location 8-C	500 g	20581

Sodium Bicarbonate, Powder, ACS		
NaHCO₃ 144-55-8	Size	Catalog #
Location 5-C	500 g	20584

Sodium meta-Bisulfite, Powder, ACS		
Na₂S₂O₅ 7681-57-4	Size	Catalog #
Location 8-D	500 g	20588

Sodium Carbonate, Anhydrous, GR		
Na₂CO₃ 497-19-8	Size	Catalog #
Location 5-C	500 g	20595
Sodium Chloride, Certified ACS		
NaCl 7647-14-5	Size	Catalog #
Location 7-A	500 g	20600
Sodium Dichromate, Dihydrate, ACS		
Na₂Cr₂O₇ 2 H₂O 7789-12-0	Size	Catalog #
Location 45-A	500 g	20604
Sodium Hydroxide, Pellets, Certified ACS		
NaOH 1310-73-2	Size	Catalog #
Location 5-D	500 g	20610
	2.5 kg	20611
Sodium Hydroxide, Solution, 50% w/w, Certified		
NaOH 1310-73-2	Size	Catalog #
Location 5-D	1 L	20612
Sodium Nitrite, Certified ACS		
NaNO₂ 7632-00-0	Size	Catalog #
Location 43-B	500 g	20621
Sodium meta-periodate, ACS		
NaIO₄ 7790-28-5	Size	Catalog #
Location 44-B	100 g	20627
Sodium Phosphate, Tribasic, Dodecahydrate		
Na₃PO₄ 12 H₂O 10101-89-0	Size	Catalog #
Location 56-A	500 g	20629
Sodium Pyrophosphate, 98%		
Na₄P₂O₇ 7722-88-5	Size	Catalog #
Location 56-B	250 g	20138

Sodium Sulfate, Anhydrous, ACS**Na₂SO₄ 7757-82-6**

Location 7-A

Size

500 g

Catalog #

20633

Sodium Sulfit, Anhydrous, Certified ACS**Na₂SO₃ 7757-83-7**

Location 56-B

Size

500 g

Catalog #

20637

Sodium L-(+)-Tartrate, Dihydrate, ACS**Na₂C₄H₄O₆ 2 H₂O 6106-24-7**

Location 56-A

Size

500 g

Catalog #

20640

Sodium Tetraborate, Decahydrate, ACS**Na₂B₄O₇ 10 H₂O 1303-96-4**

Location 45-A

Size

500 g

Catalog #

20589

Sodium Thiosulfate, Anhydrous**Na₂S₂O₃ 7772-98-7**

Location 56-A

Size

500 g

Catalog #

20641

Spill neutralizer and adsorbent

Free-flowing dry agents for spill treatment.

Location 4-B

Type

Acid

Caustic

Solvent

Size

2.5 Lb

2 Lb

1 Lb

Catalog #

20800

20801

20802

Starch, Soluble, Powder, Certified ACS**(C₆H₁₀O₅)_n 9005-84-9**

Location 56-C

Size

500 g

Catalog #

20650

Succinic ACID, Certified**HO₂CCH₂CH₂CO₂H 110-15-6**

Location 56-B

Size

500 g

Catalog #

20826

Sulfuric Acid, 95-98%, Certified ACS Plus**H₂SO₄ 7664-93-9**

Location 38-A, B

Size

500 mL

2.5 L

Catalog #

20666

20665

Talc, Powder, Laboratory Grade**Mg₃(SiO₃)₃(Si(O)(OH)₂) 14807-96-6**

Location 5-C

Size

500 g

Catalog #

20668

L-(+)-Tartaric Acid, Powder, ACS**HOOC(CHOH)₂COOH 87-69-4**

Location 56-B

Size

500 g

Catalog #

20659

Tetrahydrofuran, HPLC, inhibitor-free**CH₂(CH₂)₂CH₂O THF 109-99-9**

Location 66-A, B

Size

4 L

Catalog #

20674

Toluene, Certified ACS**C₆H₅CH₃ 108-88-3**

Location 54-B,C

Size

500 mL

Catalog #

20679

4 L

20680

2,2,4-Trimethylpentane, HPLC, >=99%**(CH₃)₃CCH₂CH(CH₃)₂ 540-84-1**

Location 63-A

Size

1 L

Catalog #

20477

Urea, Certified ACS**NH₂CONH₂ 57-13-6**

Location 7-A

Size

500 g

Catalog #

20702

Water, HPLC Grade**H₂O 7732-18-5**

Location 4-C

Size

1 L

Catalog #

20014

Xylenes, Certified ACS**C₆H₄(CH₃)₂ 1330-20-7**

Location 63-B

Size

500 mL

Catalog #

20707

Zinc, Metal, Shot, Certified ACS**Zn 7440-66-6**

Location 66-B

Size

500 g

Catalog #

20713

Zinc Sulfate, Heptahydrate, Certified ACS**ZnSO₄ 7 H₂O 7446-20-0**

Location 56-B

Size

100 g

Catalog #

20721